

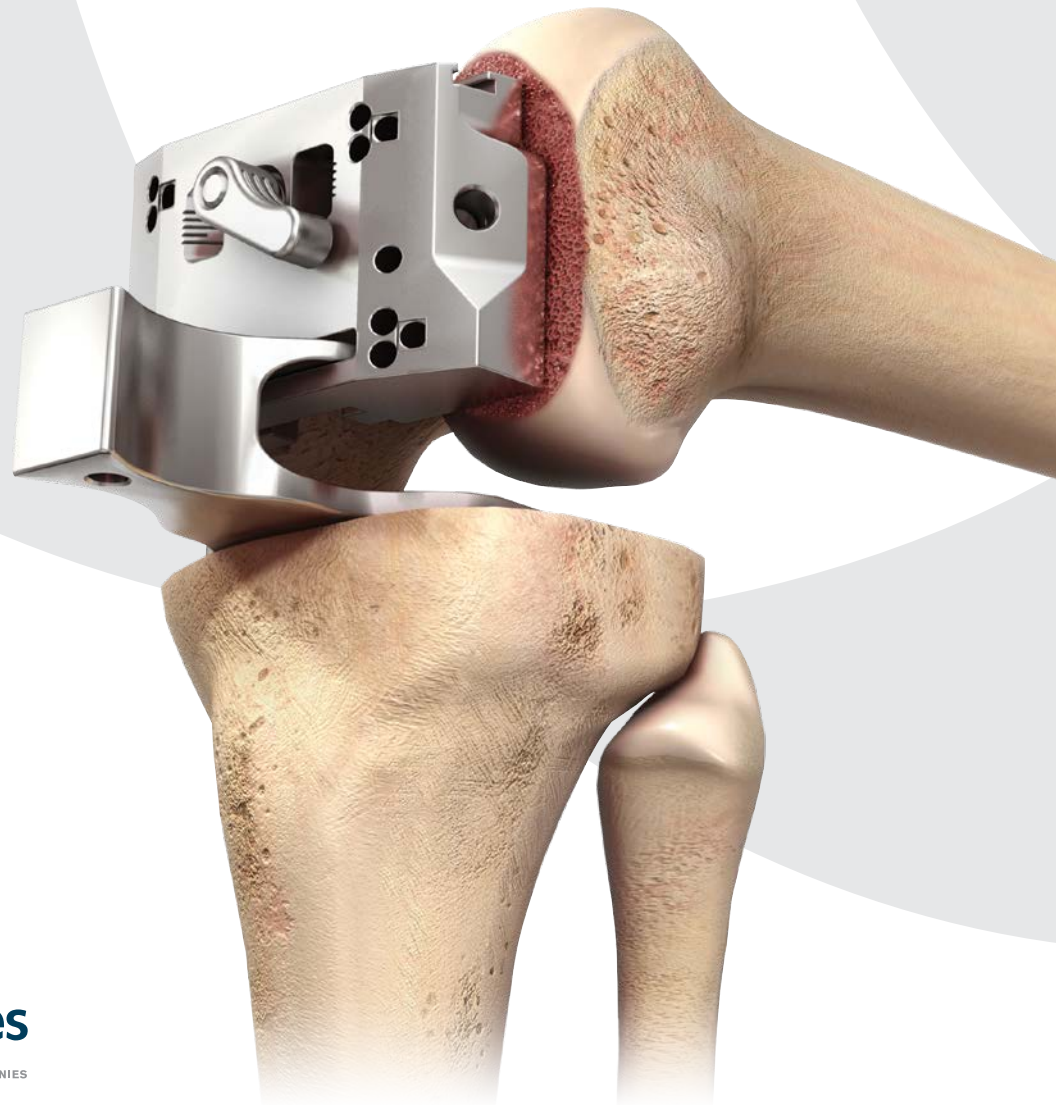

# SIGMA<sup>®</sup> Primary Knee System

Balanced Surgical Technique



# Introduction

---

Contemporary total knee arthroplasty demands high performance instrumentation that provides enhanced efficiency, precision and flexibility. Through a program of continuous development, DePuy Synthes Joint Reconstruction now offers a single system of High Performance instruments that supports your approach to knee replacement surgery.

This surgical technique provides instruction on the implantation of the SIGMA® Knee System Family of Fixed Bearing and Rotating Platform Knees utilizing the balanced resection instrumentation.

There are several approach options available to the surgeon, the most common are: medial parapatellar, mini-midvastus and mini-subvastus.

# Content

<b>Surgical Summary</b>	2
<b>Incision and Exposure</b>	4
<b>Pattela Resection</b>	7
<b>Tibial Jig Assembly</b>	9
<b>Lower Leg Alignment</b>	10
<b>Tibial Resection</b>	12
<b>Femoral Alignment</b>	13
<b>Distal Femoral Resection</b>	16
<b>Extension Gap Assessment and Balancing</b>	17
<b>Femoral Sizing (Optional)</b>	18
<b>Femoral Rotation</b>	19
<b>Femoral Preparation - A/P and Chamfer Cuts</b>	22
<b>Femoral Resection Notch Cuts</b>	24
<b>Measuring the Flexion Gap</b>	25
<b>Trial Components (For Fixed Bearing, see Appendix A)</b>	26
<b>Tibial Preparation - MBT</b>	29
<b>Final Patella Preparation</b>	31
<b>Cementing Technique</b>	32
<b>Final Component Implantation</b>	33
<b>Closure</b>	34
<b>Appendix A: Fixed Bearing Modular Tibial Preparation</b>	35
<b>Appendix B: Tibial I.M. Jig Alignment</b>	39
<b>Appendix C: Spiked Uprod</b>	42
<b>Appendix D: Femoral Finishing</b>	45
<b>Appendix E: Femoral Finishing (Alternative)</b>	46
<b>Ordering Information</b>	47

# Surgical Summary

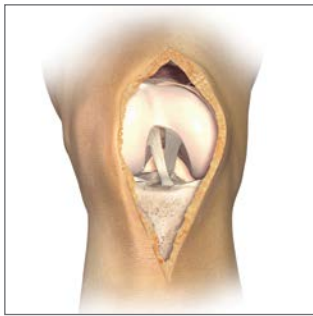

**Step 1:** Incision and exposure



**Step 2:** Patellar resection



**Step 3:** Lower leg alignment



**Step 4:** Tibial resection

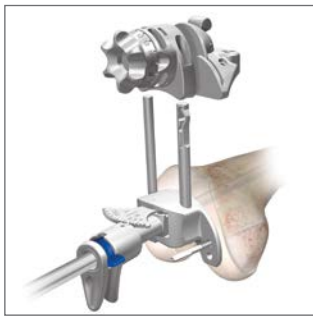

**Step 5:** Femoral alignment

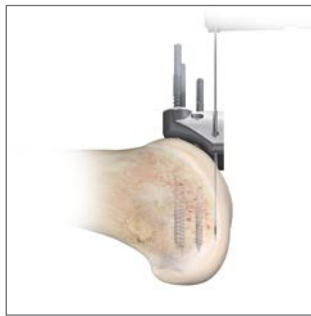

**Step 6:** Distal femoral resection

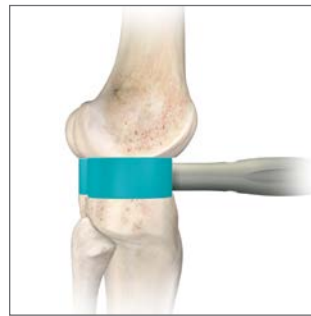

**Step 7:** Soft tissue balancing

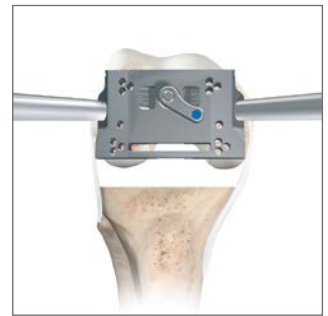

**Step 8:** Femoral rotation



**Step 9:** Femoral preparation



**Step 9:** Femoral resection notch cuts (alternative)

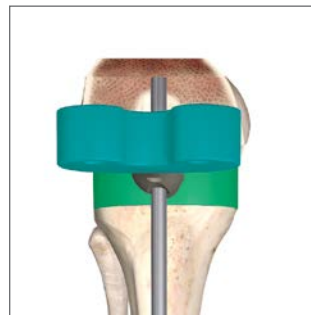

**Step 10:** Determine flexion gap



**Step 11:** Trial reduction



**Step 12:** Tibial preparation



**Step 13:** Final patella preparation



**Step 14:** Final component implantation

# Incision and Exposure

The SIGMA High Performance Instrumentation is designed for use with and without Ci Computer Assisted Surgery, for both open and minimal invasive approaches to the knee.

Make a straight midline skin incision starting from 2 to 4 cm above the patella, passing over the patella, and ending at the tibial tubercle (Figure 1).

There are three approach options available for the surgeon: medial parapatellar, mini-midvastus and mini-subvastus.

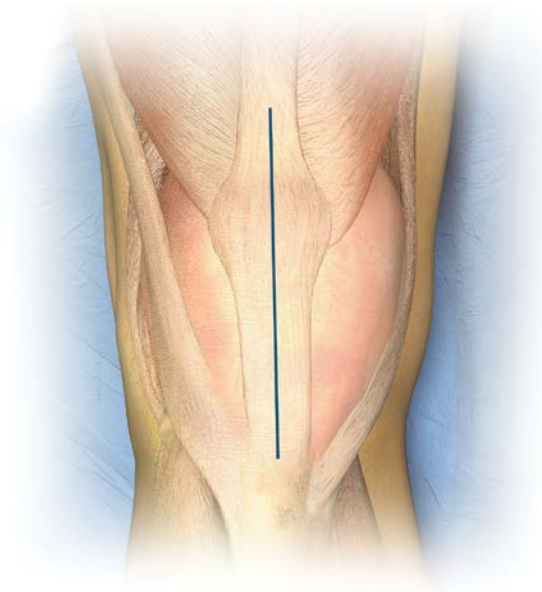

Figure 1

## **For surgeons choosing the medial parapatellar approach (Figure 2):**

Make a medial parapatellar incision through the retinaculum, the capsule and the synovium, with neutral alignment or with varus deformity. The medial parapatellar incision starts proximal (4 cm) to the patella, incising the rectus femoris tendon longitudinally, and continues distally around the medial aspect of the patella and ligamentum patella stopping just medial to the tibial tubercle (Figure 2). Following this incision, evert the patella laterally to expose the entire tibio-femoral joint.

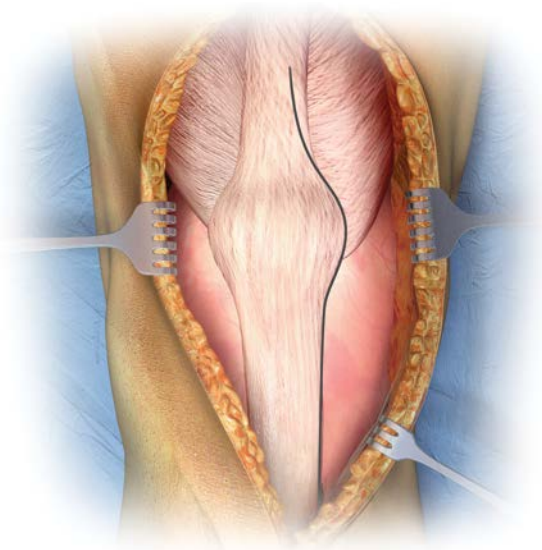

Figure 2

---

**For surgeons choosing the mini-midvastus approach (Figure 3):**

The midvastus approach starts 3-4 cm in the middle of the Vastus Medialis Obliquus (VMO), running distal and lateral to the muscle fibers towards the rectus femoris, splitting the VMO.

Continue the incision distally around the medial aspect of the patella and ligamentum patella stopping just medial to the tibial tubercle (Figure 3). Following this incision, evert the patella laterally to expose the entire tibio-femoral joint.

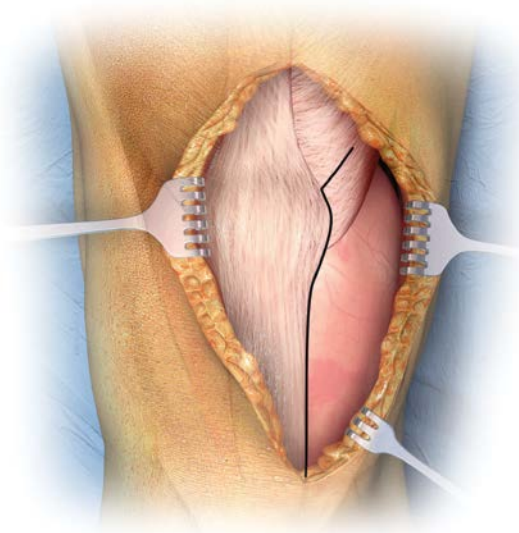

Figure 3

**For surgeons choosing the subvastus approach:**

The subvastus approach starts by lifting the VMO with a 90 degree stomp hook. A 3-4 cm incision is made in the capsule underneath the VMO, running horizontal from medial to lateral towards the mid portion of the patella. The incision continues distally around the medial aspect of the patella and ligamentum patella stopping just medial to the tibial tubercle (Figure 4). Following this incision, evert the patella laterally to expose the entire tibio-femoral joint.

**Note:** When having difficulties in correctly placing the SIGMA High Performance Instruments in any of these approaches, the incision should be further extended to avoid over-retraction of the soft tissues.

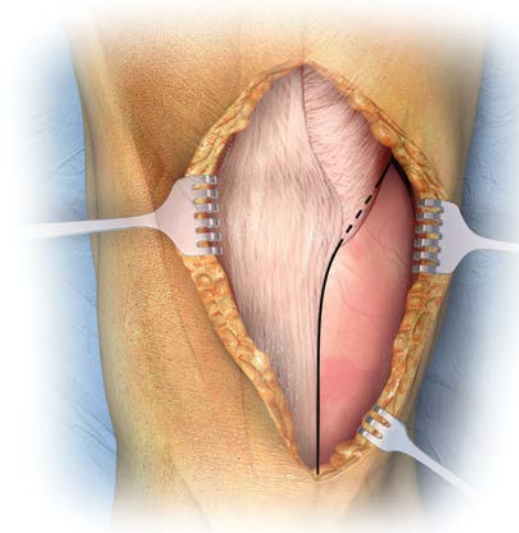

Figure 4

---

Excise hypertrophic synovium if present and a portion of the infrapatella fat pad to allow access to the medial, lateral and intercondylar spaces.

Remove all osteophytes at this stage as they can affect soft tissue balancing (Figure 5).

**Note: Particular attention should be given to posterior osteophytes as they may affect flexion contracture or femoral rotation.**

Evaluate the condition of the posterior cruciate ligament (PCL) to determine the appropriate SIGMA Component to use. Resect the PCL if required.

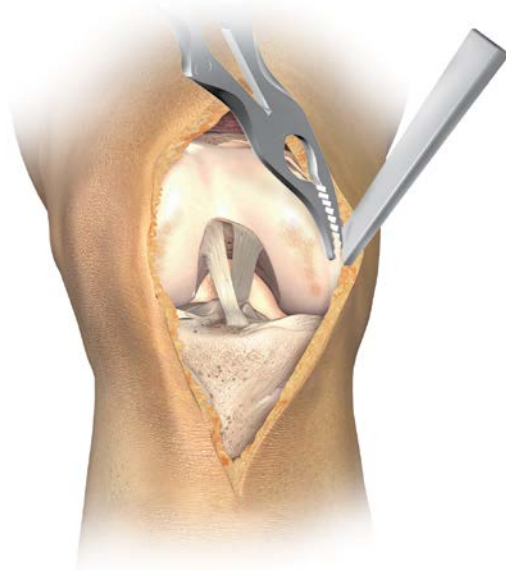

Figure 5



# Patella Resection

Resection and preparation of the patella can be performed sequentially or separately, as desired, and can be performed at any time during surgery.

Determine the thickness of the patella and calculate the level of bone resection (Figure 6). The thickness of the resurfaced patella should be the same as the natural patella. There should be equal amounts of bone remaining in the medial/lateral and superior/ inferior portions of the patella.

**Note:** As a general rule, the resection usually progresses from the medial chondro-osseous function to the lateral chondro-osseous function.

Select a patella stylus that matches the thickness of the implant to be used. The minimum depth of the patella resection should be no less than 8.5 mm (Figure 7).

However, when the patella is small, a minimal residual thickness of 12 mm should be maintained to avoid fracture.

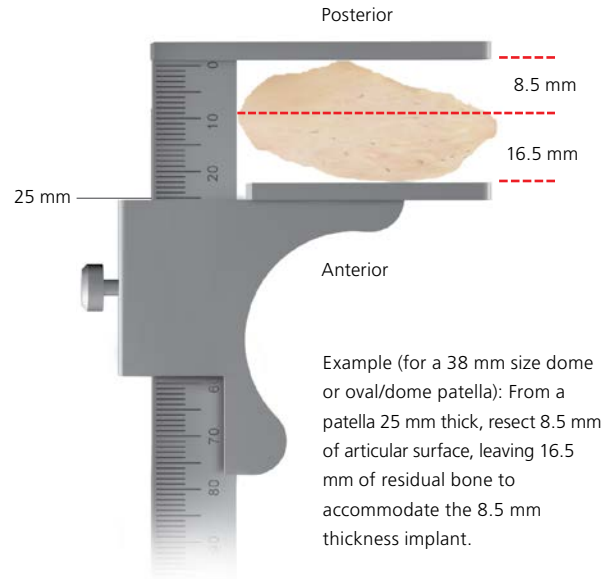

Figure 6

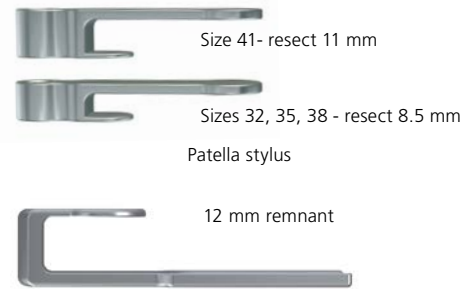

Figure 7

A 12 mm remnant stylus can be attached to the resection guide resting on the anterior surface of the patella, to avoid over-resection (Figure 8).

Place the leg in extension and evert the patella. Next position the patella resection guide with the sizing stylus against the posterior cortex of the patella with the serrated jaws at the superior and inferior margins of the articular surface. Close the jaws to firmly engage the patella (Figure 9).

Remove the stylus and perform the resection using an oscillating saw through the saw capture and flush to the cutting surface (Figure 10).

A patella wafer can be hand placed on the resected surface if required to protect the patella bone bed.



Figure 8

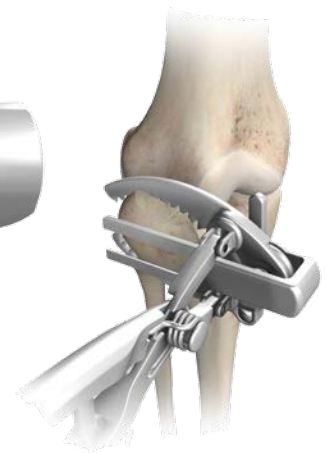

Figure 9

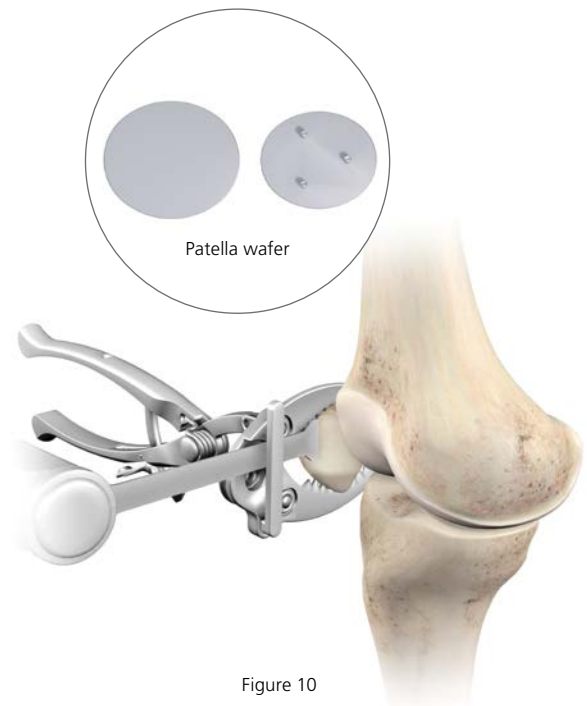

Figure 10

# Tibial Jig Assembly

The tibia can now be resected to create more room in the joint space.

Assemble the appropriate 0-3 degree, left/right or symmetrical cutting block to the tibial jig uprod. Slide the tibial jig uprod into the ankle clamp assembly (Figure 11).

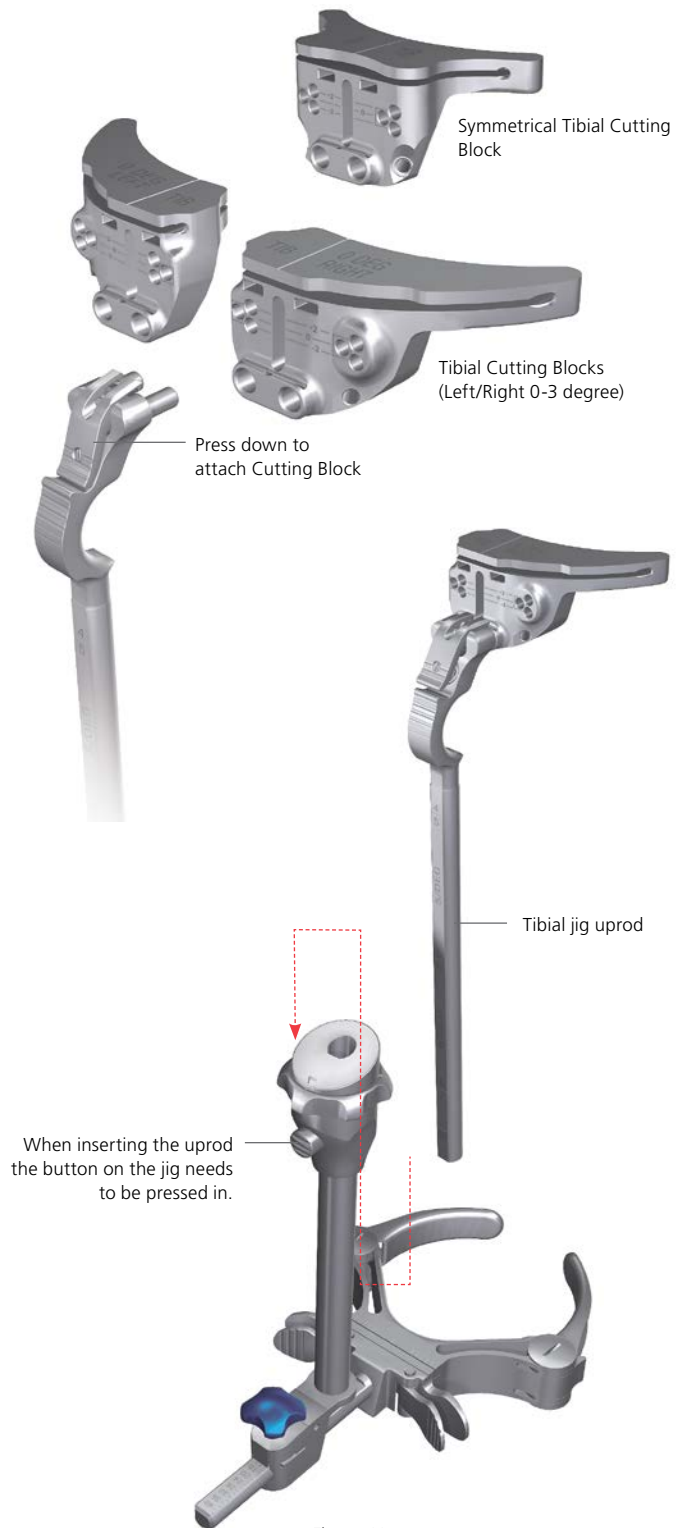

Figure 11

# Lower Leg Alignment

Place the knee in 90 degrees of flexion with the tibia translated anteriorly and stabilized. Place the ankle clamp proximal to the malleoli (Figure 12). Align the proximal central marking on the tibia cutting block with the medial one third of the tibial tubercle to set rotation. To provide stability, insert a central pin through the vertical slot in the cutting block to aid stability (Figure 12). Push the quick release button to set the approximate resection level.

## Varus/Valgus

Align the tibial jig ankle clamp parallel to the transmalleolar axis to establish rotational alignment (Figure 13). The midline of the tibia is approximately 3-5 mm medial to the transaxial midline. Translate the lower assembly medially (usually moving it one-two vertical marks in from the mark furthest out). Each marking is 2.5 mm apart. There are also vertical scribe marks for reference aligning to the middle of the talus (Figure 14).

## Slope

The tibial jig uprod and ankle clamp are designed to prevent an adverse anterior slope. On an average size tibia this guide gives approximately a 0 degree (Figure 15) tibial slope when the slope adjustment is translated anteriorly until it hits the stop. In some cases, a slight amount of slope will remain (1-2 degrees) (Figure 16).



Figure 12

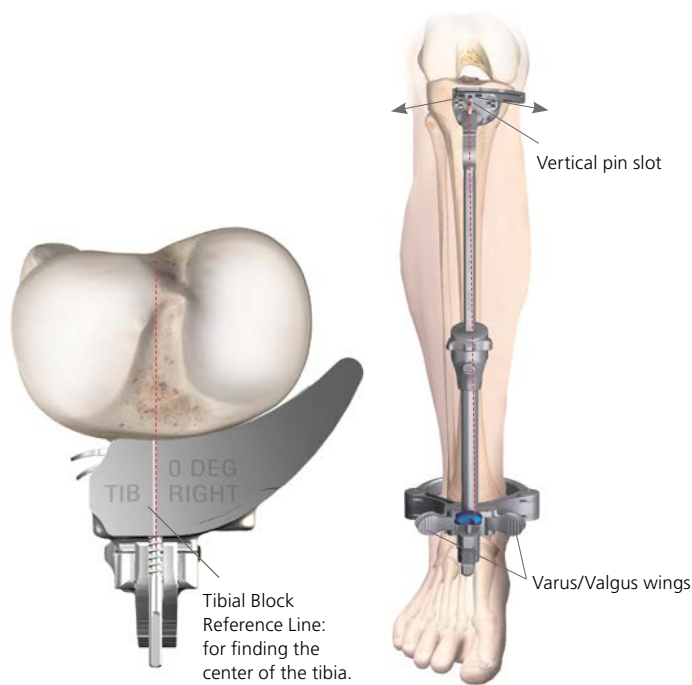

Figure 13

Figure 14

Increase the angle of the tibial slope to greater than 0 degrees if the patient has a greater natural slope (Figure 15). First, unlock the slope adjustment lock and then translate the tibial slope adjuster anteriorly until the desired angle is reached. For a Cruciate Substituting (CS) design, a 0 degree posterior slope is recommended. For a Cruciate Retaining (CR) design, a 3 degree posterior slope is recommended.

As each patient's anatomy varies, the EM tibial uprod can be used for both smaller and larger patients. The length of the tibia influences the amount of slope when translating the adapter anteriorly. The 0 degree default position can be overridden by moving the slope adjuster closer to the ankle using the slope override button.

On the uprod 5, 6 and 7 zones are present, which correspond to the length of the tibia. These markings can be used to fine-tune the amount of slope. When the uprod shows a larger zone (7) marking, this indicates that when the lower assembly is translated 7 mm anterior, it will give an additional 1 degree of posterior slope (Figure 16).

### Height

When assessing from the less damaged side of the tibial plateau set the stylus to 8 mm or 10 mm. If the stylus is placed on the more damaged side of the tibial plateau, set the stylus to 0 mm or 2 mm. Adjustment of resection height on the stylus should be done outside the joint space before locating the stylus in the cutting block.

If planning to resect through the slot, position the foot of the tibial stylus marked "slotted" into the slot of the tibial cutting block (Figure 17). If planning to resect on top of the cutting block, place the foot marked "non-slotted" into the cutting slot.

The final resection level can be dialed in by rotating the fine-tune mechanism clockwise (upward adjustment) or counterclockwise (downward adjustment). Care should be taken with severe valgus deformity, not to over resect the tibia.



Figure 15

Figure 16

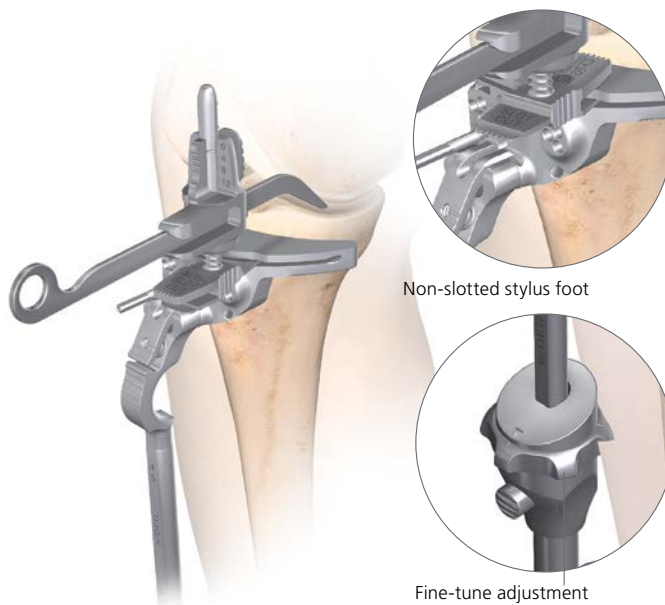

Figure 17

# Tibial Resection

**Optional:** The alignment tower may be introduced at this point into the two slots on the tibial cutting block. With the alignment tower in place, drop an alignment rod running from the tibial plateau to the ankle. This may be helpful in assessing alignment (Figure 18).

In addition a second alignment rod may be placed into the tower in the M/L plane (Figure 19). This will assist in making sure the tibia is not cut in varus or valgus.

After the height has been set, pin the block through the 0 mm set of holes (the stylus may need to be removed for access). +/-2 mm pinholes are available on the resection blocks to further adjust the resection level where needed.

The block can be securely fixed with a convergent non-headed pin (Figure 20).



Figure 18



Figure 19

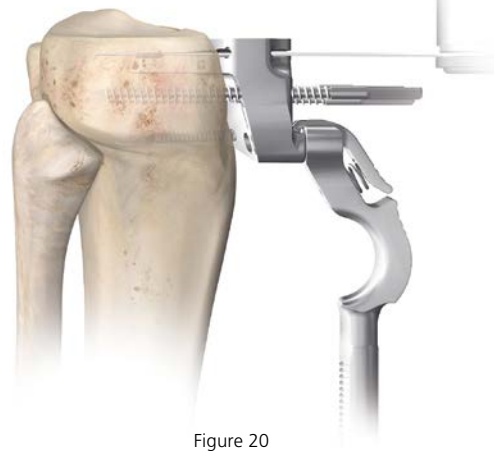

Figure 20

# Femoral Alignment

Enter the medullary canal at the midline of the trochlea, 7 mm to 10 mm anterior to the origin of the PCL. Drill to a depth of approximately 5 cm to 7 cm. Take care to avoid the cortices (Figure 21).

Stop drilling just before the step portion on the drill. Do not use the step portion on the drill, as this will have an adverse affect on the I.M. rod position when balancing.

Attach the T-handle to the I.M. rod and slowly introduce the rod into the medullary canal, to the level of the isthmus (Figure 22).

**Note:** Avoid using excessive force to drive the rod into the I.M. canal. If a large amount of force is required to insert the rod, the femoral canal may be overly bowed, or the distal entry hole may be too tight to permit the rod to center in the canal. Should this be encountered, using a shorter I.M. rod may be more appropriate. Enlarging the distal entry hole may help as well.

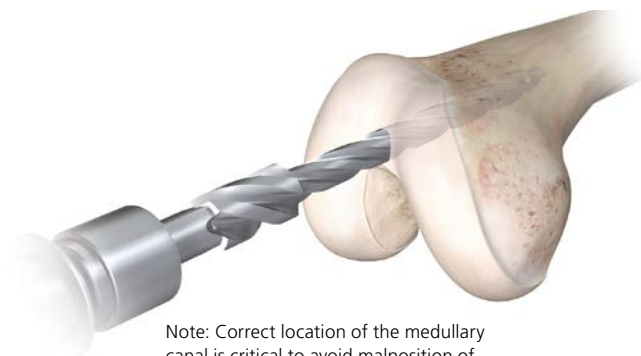

Note: Correct location of the medullary canal is critical to avoid malposition of the femoral component.

Figure 21

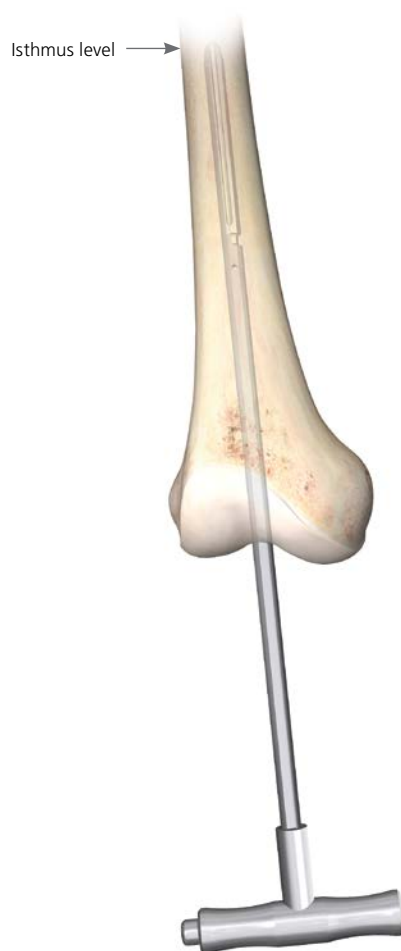

Figure 22

Use pre-operative radiographs to define the angle between the femoral, anatomical and mechanical axis. Set the valgus angle (left or right - 0 degrees to 9 degrees) on the femoral alignment guide by compressing the two triggers and lock in place by rotating the blue locking lever clockwise (Figure 23).

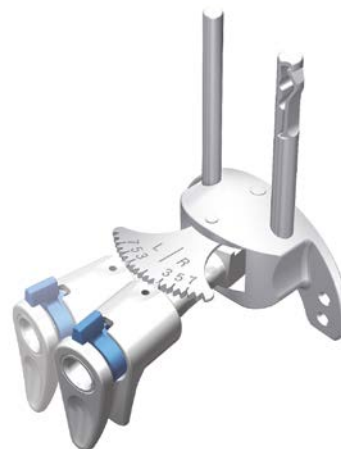

Figure 23

Remove the T-handle and place the femoral alignment guide on the I.M. rod and seat against the distal femur (Figure 24).

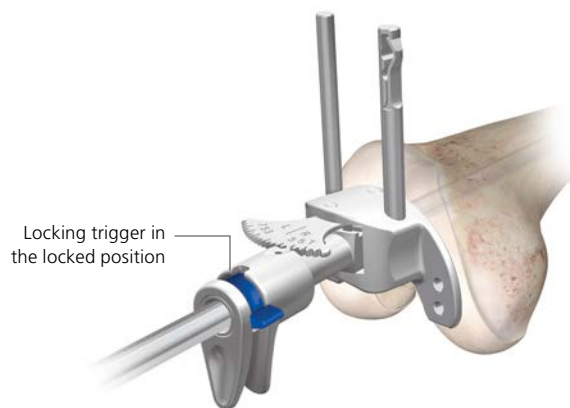

Figure 24

Rotate the knob counterclockwise until the arrow is pointing to the padlock symbol. Slide the femoral cutting block in the femoral block connector. Rotate the knob clockwise to set the desired resection level. Every click moves the femoral cutting block 1 mm proximal or distal and represents a slotted resection. An open resection will resect 4 mm less distal femur, so when an open resection is desired, the dial should be set to take an increased 4 mm of femur. Place the block connector in the femoral resection guide so that the tang on the connector slides in to the cutting slot on the cutting block. The trigger should engage in the hole behind the slot (Figure 25).

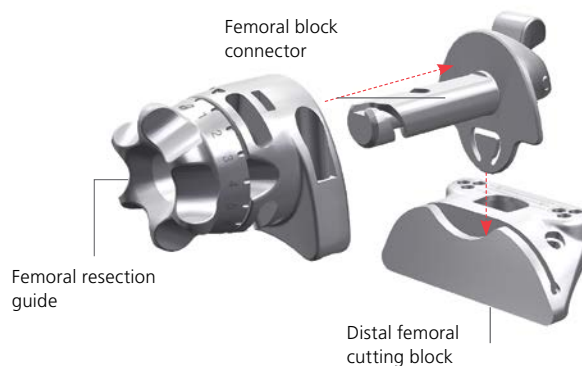

Figure 25



Position the resection guide over the two legs of the distal femoral alignment guide until the distal cutting block touches the anterior femur (Figure 26).

**Optional:** Adjust the internal/external rotation of the alignment guide with reference to the trochlear groove. When rotation is correct, secure the alignment guide by inserting one threaded pin through the medial hole.

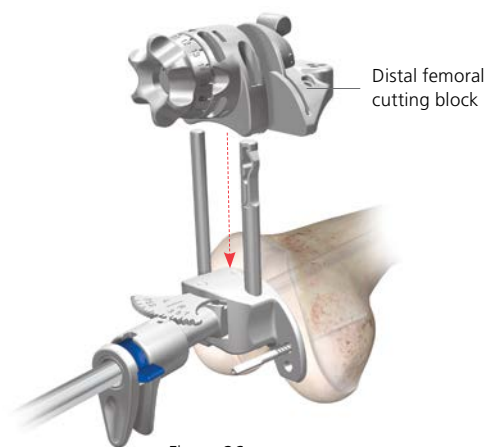

Figure 26

Adjust the medial/lateral placement of the resection block as desired and rotate until firmly seated on the anterior condyles.

Secure the cutting block to the femur with two threaded pins through the holes marked with a square. This will allow a +2 or -2 mm adjustment to be made.

Resect at least 9 mm of distal femoral bone from the most prominent condyle (Figure 27).

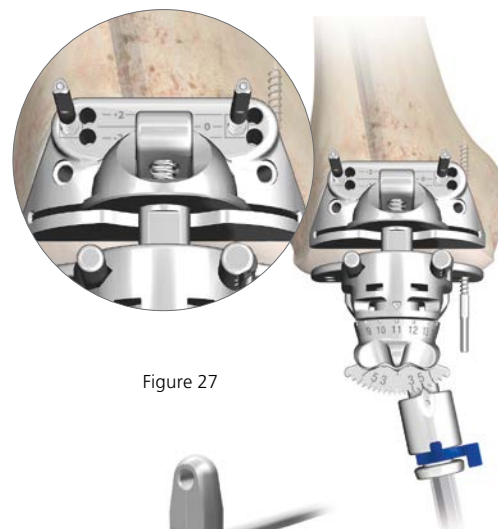

Figure 27

**Optional:** The alignment tower may be introduced at this point into the two slots on the distal resection device. With the alignment tower in place, connect two alignment rods, creating a line that runs from the center of the hip to the ankle. This may be helpful in assessing the mechanical axis (Figure 28).

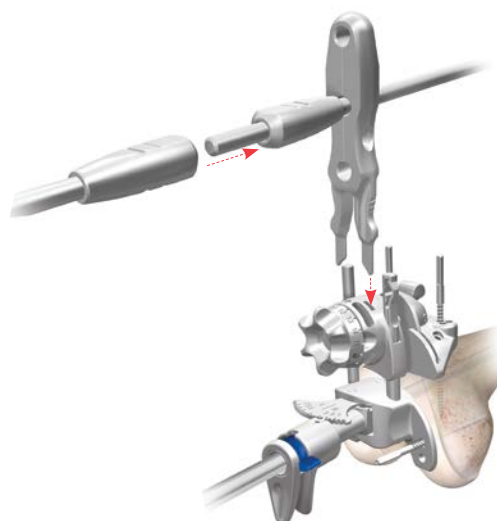

Figure 28

# Distal Femoral Resection

After the correct amount of resection is set, add a convergent pin through the medial hole in the block to aid stability (Figure 29).

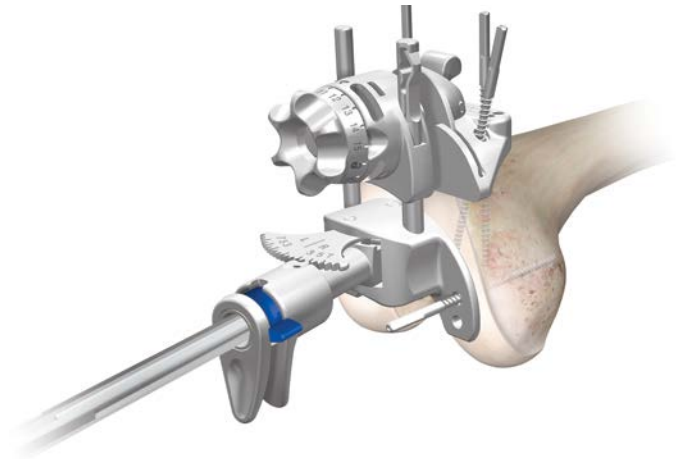

Figure 29

## Removal of the Femoral Alignment Guide

First attach the T-handle to the I.M. guide. Then unlock the cutting block from the block connector, using your thumb and index finger to release the attachment. Slide the femoral resection guide upwards on the alignment guide legs until the block connector disengages the cutting block and in one motion remove the femoral alignment guide by pulling the instruments distally in the direction of the T-handle (Figure 30).

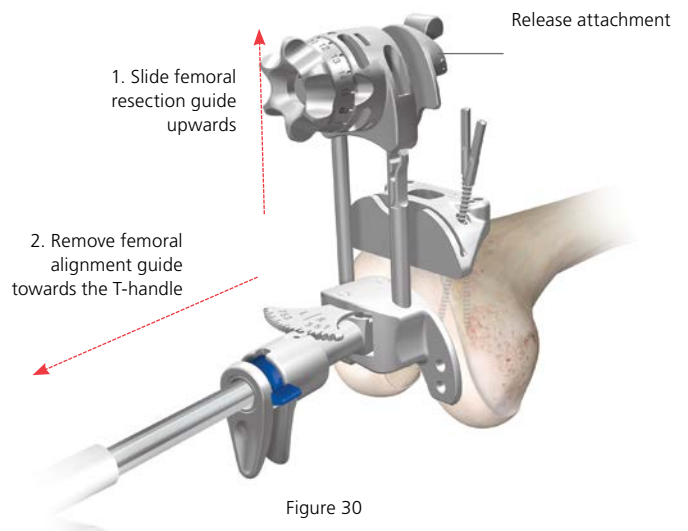

Figure 30

Perform the distal femoral resection (Figure 31). Resect at least 9 mm from the most prominent condyle. After performing the distal resection, use the power pin driver to remove the threaded pins.

**Optional:** If drill pins or Steinmann pins were used to fixate the cutting block, the pin puller can be used to extract the pins.



Figure 31

# Extension Gap Assessment and balancing

Place the knee in full extension and apply lamina spreaders medially and laterally. The extension gap must be rectangular in configuration with the leg in full extension. If the gap is not rectangular, the extension gap is not balanced and appropriate soft tissue balancing must be performed (Figure 32).

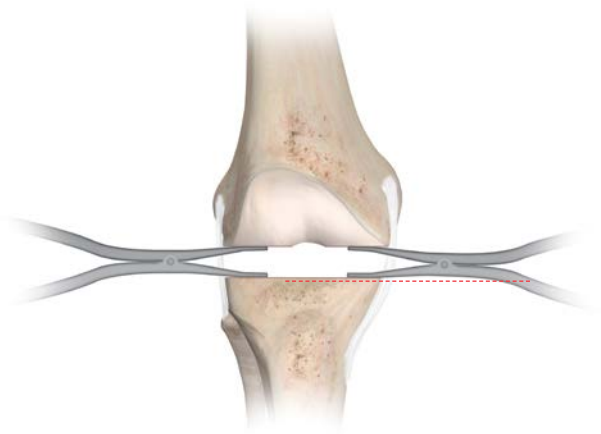

Figure 32

A set of specific fixed bearing and mobile bearing spacer blocks are available. Every spacer block has two ends, one for determining the extension gap and one for the flexion gap. At this step in the procedure, the extension gap side of the spacer block can be used to determine the appropriate thickness of the tibial insert and to validate the soft tissue balance (Figure 33).

Introduce the alignment rod through the spacer block. This may be helpful in assessing alignment (Figure 34).

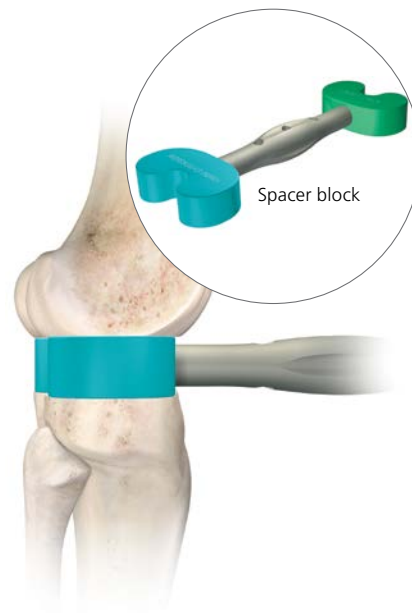

Figure 33



Figure 34

# Femoral Sizing (Optional)

Place the Fixed Reference sizing guide (Figure 35) or the Classic sizing guide against the resected distal surface of the femur, with the posterior condyles resting on the posterior plate of the guide.

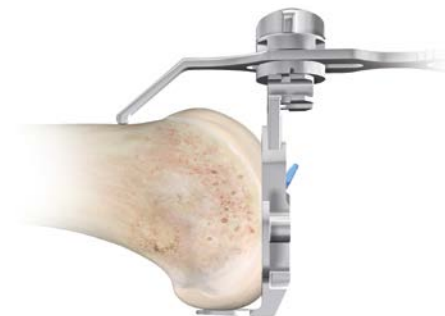

Figure 35

**Optional:** Secure the sizing guide against the distal femur with threaded head pins (Figure 36).

Place the sizing guide stylus on the anterior femur with the tip positioned at the intended exit point on the anterior cortex to avoid any potential notching of the femur. A scale on the surface of the stylus indicates the exit point on the anterior cortex for each size of femur. The scale is read from the distal side of the lock knob (Figure 36).

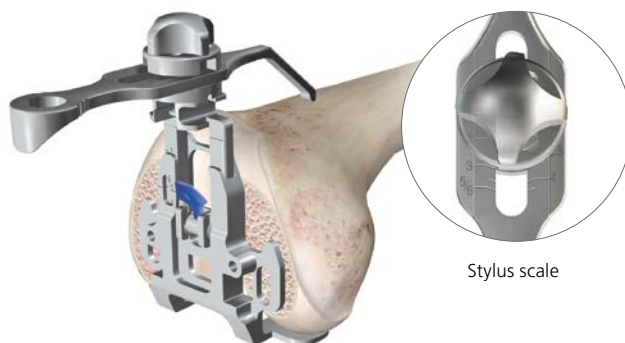

Figure 36

Tighten the blue locking lever downward and read the size from the sizing window (Figure 37).

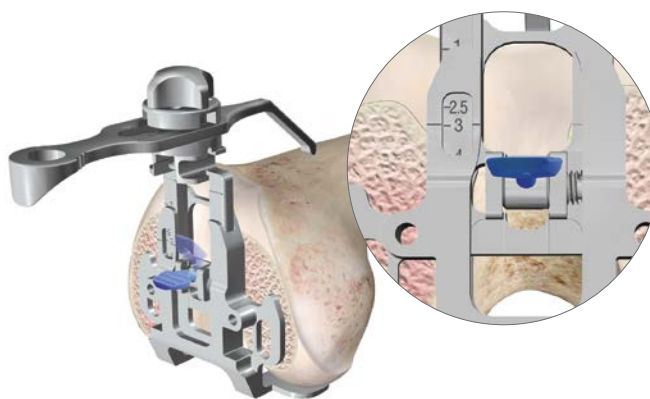

Figure 37

# Femoral Rotation

Select the appropriate balanced block, based upon the size of the femur. Then select the appropriate I.M. rod (3 or 5 degrees) with the correct left/right designation positioned anteriorly, as determined during pre-operative X-ray analysis. Slide the rod into the SIGMA Knee or RP-F balanced resection block. Insert the I.M. rod into the distal femoral I.M. canal taking care to avoid over-pressurization (Figure 38).

**Note:** The RP-F and standard SIGMA Blocks are visually very similar. To help differentiate them, the RP-F block has the letters “RP-F” engraved on it, and a series of grooves rising from the posterior cut face.

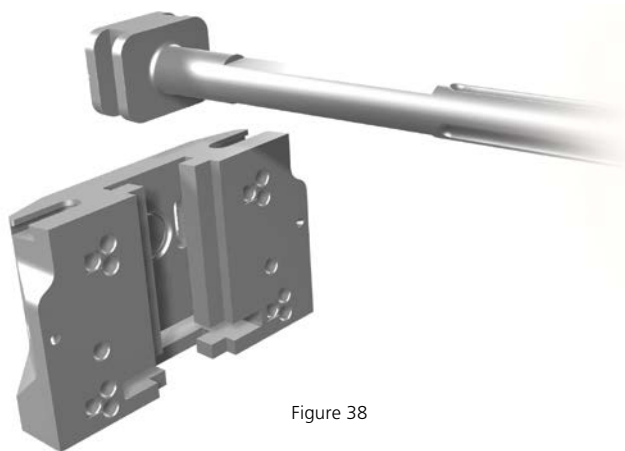

Figure 38

Assemble the femoral stylus to the medial anterior slot of the SIGMA Knee or RP-F balanced block and tighten it by turning the knurled screw clockwise (Figure 39).

**Note:** Care should be taken to ensure the stylus is completely tightened down on the balanced block.

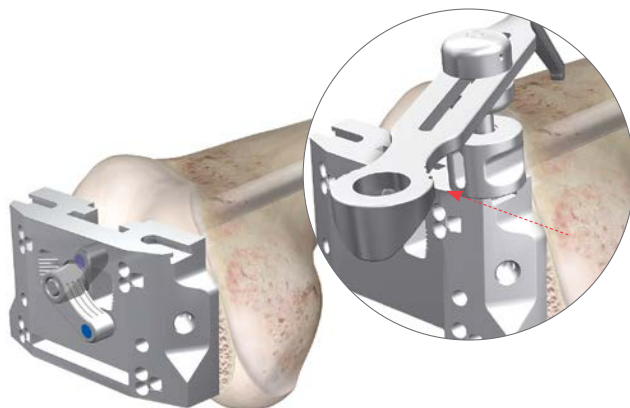

Figure 39

Ensure the A/P resection block is unlocked and lower the assembly on the I.M. plate. Translate the block posteriorly until the anterior femoral stylus contacts the anterior cortex of the femur. The stylus should rest on the anterior femur at the approximate exit point of the anterior cut. Fix the position of the balanced block by turning the blue locking mechanism clockwise. Final rotation has not been fixed at this stage. Remove the anterior femoral stylus (Figure 40).



Figure 40

Two handles can be attached to the balanced cutting block to help in visualizing the degree of rotation of the balanced cutting block in respect to the transepicondylar axis (Figure 41).

Rotation is determined with the knee in 90 degrees of flexion such that the posterior surface is parallel to the resected tibial plateau. Introduce the femoral guide positioner, (with the appropriate tibial shim added) into the joint space engaging the posterior slot of the balanced resection guide (Figure 42). The femoral guide positioner thickness should mirror the extension gap previously determined with the spacer block.

The knee may be slightly flexed or extended until the positioner lies flat on the resected proximal tibia.

Alternatively lamina spreaders or spacer blocks (Figure 42) can be used.

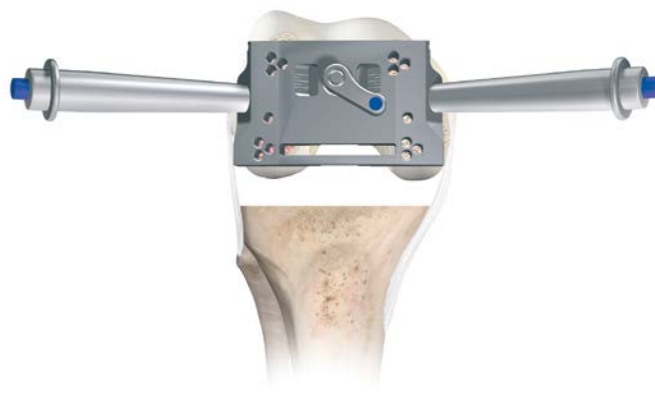

Figure 41

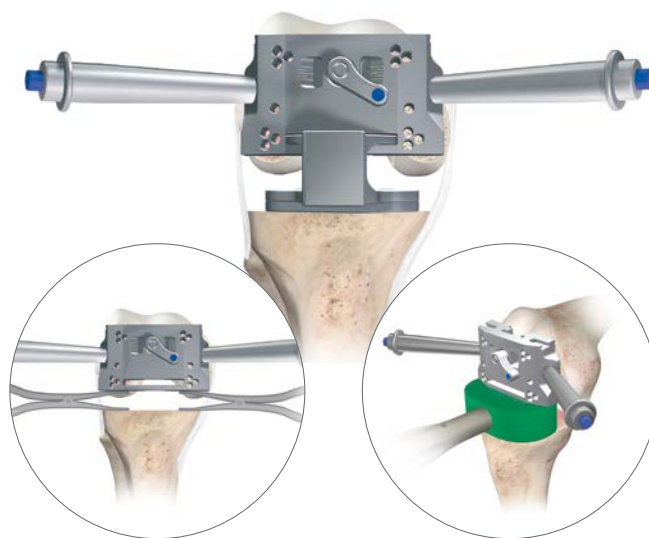

Figure 42

If the flexion gap is too lax, thicker tibial shims should be added to ensure that the positioner fits snugly (Figure 43).

**Note: If the flexion gap no longer matches the extension gap, the distal cut will need to be revisited.**

Re-evaluate the tibial alignment by putting the external alignment rod through the hole at the end of the femoral guide positioner (Figure 43).

The femoral rotation is set by the femoral guide positioner and is based on the principle of equal compartment tension and balanced collateral ligaments. Using the femoral guide positioner this balance should automatically occur, because the femur can freely rotate around the I.M. plate.

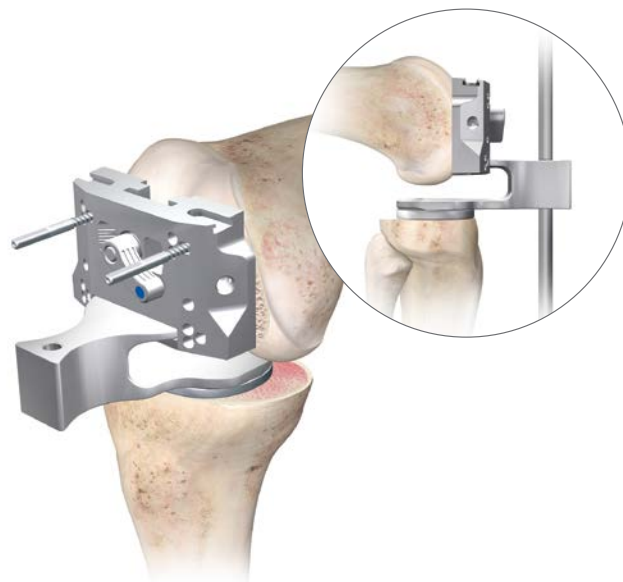

Figure 43

All adjustments should be made prior to pinning the block. Pin the A/P resection block to the distal femur using the two neutral central holes (marked with a square) that are located in the anterior or posterior cluster of three pin holes. The decision to pin through the neutral posterior pin holes or neutral anterior pin holes should be based upon the surgeon's preferred workflow (Figure 44). Remove the Femoral Guide positioner.

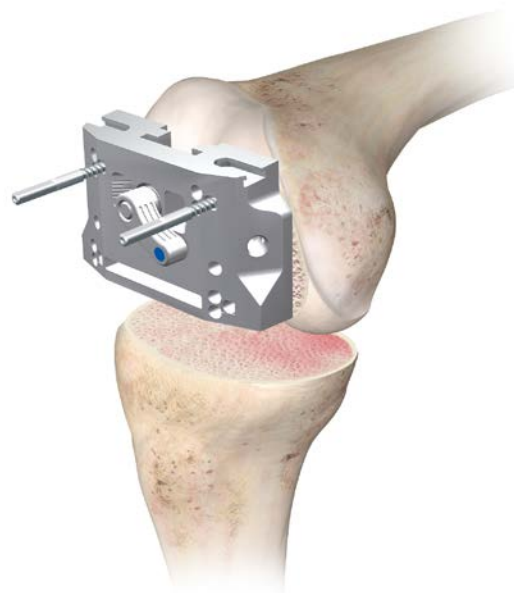

Figure 44

# Femoral Preparation - A/P and Chamfer Cuts

Remove the balanced femoral cutting block, leaving the pins in the distal femur. Select the SIGMA or SIGMA RP-F Fixed Reference A/P Chamfer Block that matches the femur size. Slide the block onto the pins through the appropriate pin holes (Figure 45).

The RP-F and standard SIGMA Cutting Blocks look very similar. Care should be taken not to confuse the blocks as this will result in under or over resection of the posterior condyles. The RP-F block can be identified through the letters "RP-F" on the distal face, and a series of grooves along the posterior cut slot.

Place the block over the two threaded pins through the 0 mm pinholes.

**Note: The block may be shifted 2 mm anteriorly or posteriorly by selecting one of the offset holes around the "0" hole.**

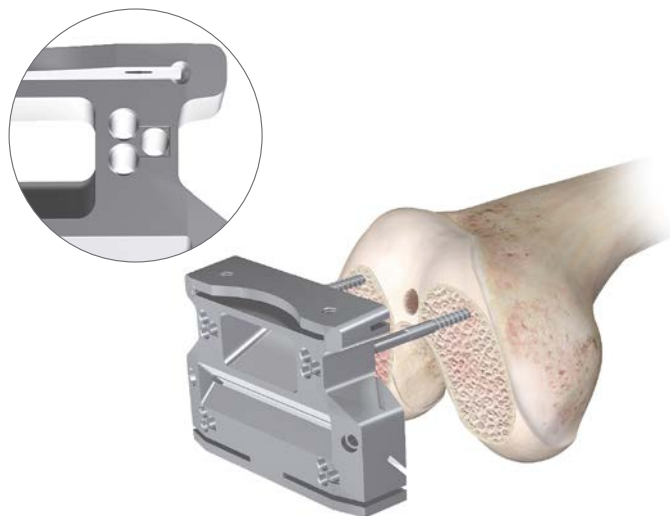

Figure 45

After confirming cut placement with the reference guide, or angel-wing, insert threaded headed pins into the convergent pin holes on the medial and lateral aspect of the A/P chamfer block (Figure 46).

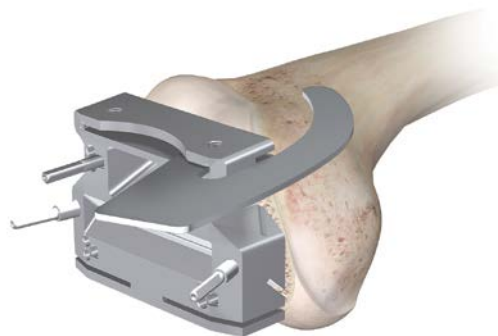

Figure 46

Resect the anterior and posterior femur (Figures 47 and 48).



Figure 47



Place retractors to protect the MCL medially and the popliteal tendon laterally.

**Note:** The posterior saw captures are open medially and laterally to ensure completed saw cuts over a wide range of femoral widths. To reduce the risk of inadvertent sawblade kickout when making posterior resections, insert the sawblade with a slight medial angle prior to starting the saw.

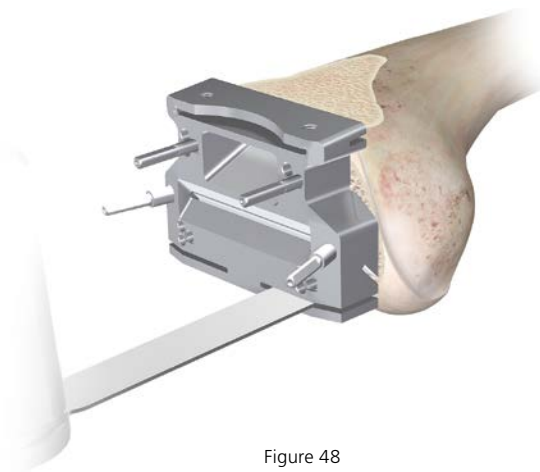

Figure 48

Remove the initial locating pins and proceed with the chamfer cuts (Figures 49 and 50).

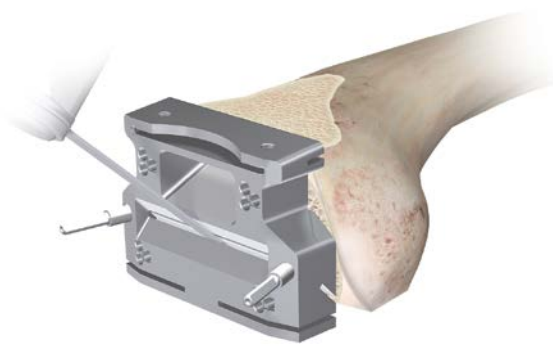

Figure 49

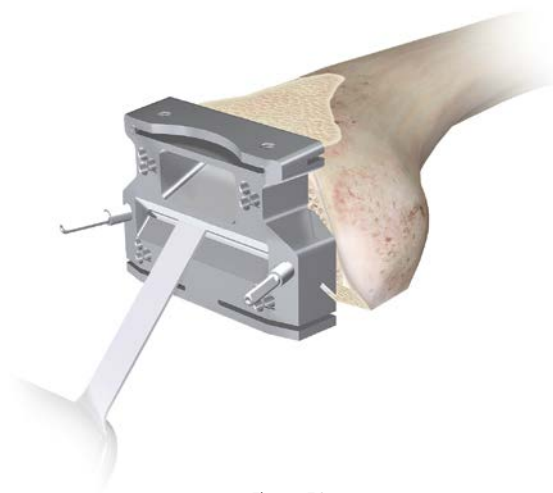

Figure 50

# Femoral Resection - Notch cuts

When using a stabilized SIGMA or SIGMA RP-F Component, select and attach the appropriate femoral Notch Guide. The SIGMA RP-F Component and standard SIGMA Notch Guides look very similar. Care should be taken not to confuse the blocks as this will result in under-or-over resection of the box.

The SIGMA RP-F Guide can be identified through the letters "RP-F" on the anterior face, and a series of grooves along the notch distal anterior corner.



Figure 51

Position the notch guide on the resected anterior and distal surfaces of the femur. Pin the block in place through the fixation pin holes with at least three pins before any bone cuts are made (Figures 51 and 52).



Figure 52

# Measuring the Flexion Gap

The flexion side of the spacer block is used to evaluate the flexion gap. Where RP-F spacer blocks are used, flexion shims will need to be added.

An alignment rod assembled to the spacer block should pass through the center of the talus and lie parallel to the lateral tibial axis (Figure 53).



Figure 53

# Trial Components

**Note:** Either MBT or Fixed Bearing tibial components can be trialed prior to performing the tibial preparation step.

## Femoral Trial

Attach the slap hammer or universal handle to the femoral inserter/extractor. Position the appropriately sized femoral trial on the inserter by depressing the two triggers to separate the arms and push the trial against the conforming poly surface. Release the triggers so that the arms engage in the slots on the femur, and rotate the handle clockwise to lock. Position the trial onto the femur, impacting as necessary. To detach the inserter from the femur, rotate the handle counterclockwise and push the two triggers with thumb and index finger (Figure 54).



Figure 54

## Tibial Trial

Place the appropriate sized MBT tray trial onto the resected tibial surface. Position the evaluation bullet into the cut-out of the MBT tray trial (Figure 55). There are two options available to assess the knee during trial reduction. One or both may be used.

### 1. Trial reduction with the MBT tray trial free to rotate

This option is performed using a non-spiked MBT evaluation bullet. It is useful when the tibial tray component is smaller than the femoral size.

**Note:** Mobile bearing tibial insert size **MUST** match femoral component size.

With equivalent sizes the bearing rotation allowance is 8 degrees for SIGMA Knee and 20 degrees for SIGMA RP-F Instruments. For a tibial tray one size smaller than the femoral component, this bearing rotation allowance reduces to 5 degrees. In this situation, finding the neutral position with respect to the femur is therefore more important in order to prevent bearing overhang and soft tissue impingement. Position the evaluation bullet into the cut-out of the MBT tray trial.



Figure 55

---

## 2. Trial reduction with MBT tray trial fixed in place

This trial reduction can be done instead or in addition to the one described before.

Place the appropriately sized MBT tray trial onto the resected tibial surface (Figure 56).



Figure 56

Assess the position of the tray to achieve maximal tibial coverage (align the tibial tray handle with the electrocautery marks if procedure described in tibial trial 1 has been followed). The rotation of the MBT tray trial is usually centered on the junction between the medial and central one-third of the tibial tubercle. Secure the keel punch impactor to the spiked evaluation bullet and position into the cut-out of the MBT tray trial. Tap down lightly to secure the tray to the proximal tibia (Figure 57).



Figure 57

Select the tibial insert trial that matches the chosen femoral size and style, curved or stabilized, and insert it onto the MBT tray trial (Figure 58). Carefully remove the tibial tray handle and, with the trial prosthesis in place, extend the knee carefully, noting the anterior/posterior stability, medial/lateral stability and overall alignment in the A/P and M/L plane. If there is any indication of instability, substitute a tibial insert trial with the next greater thickness and repeat the reduction.

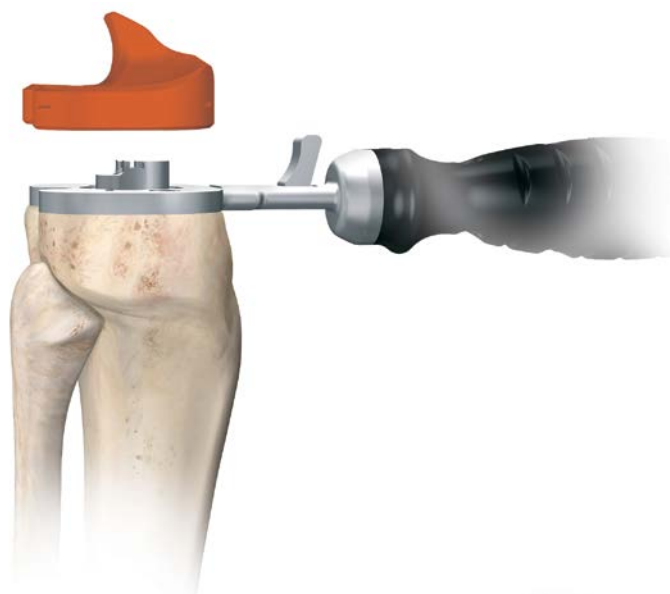

Figure 58

Select the tibial insert trial that gives the greatest stability in flexion and extension while still allowing full extension (Figure 59).

Adjust rotational alignment of the MBT tray trial with the knee in full extension, using the tibial tray handle to rotate the tray and trial insert into congruency with the femoral trial. The rotation of the MBT tray trial is usually centered on the junction between the medial and central one-third of the tibial tubercle. Overall alignment can be confirmed using the two-part alignment rod, attaching it to the tibial alignment handle (Figure 60). The appropriate position is marked with electrocautery on the anterior tibial cortex. Fully flex the knee, and remove the trial components.

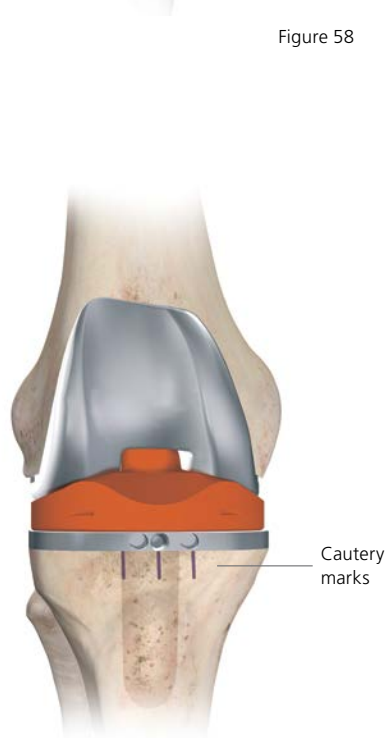

Figure 59



Figure 60

# Tibial Preparation - MBT

## Tibial Preparation

Align the tibial trial to fit with the tibia for maximum coverage or, if electrocautery marks are present, use these for alignment. Pin the trial with two pins. The tray trial allows for standard and MBT keeled (Figure 61). Attach the MBT drill tower to the tray trial. Control the tibial reaming depth by inserting the reamer to the appropriate colored line (Figures 62 and 63). An optional Modular Drill Stop is available to provide a hard stop when reaming. See table for appropriate size.

Tray Size	Line Color
1-1.5	Green
2-3	Yellow
4-7	Purple

**Note:** For cemented preparation, select the “Cemented” instruments, and for non-cemented or line-to-line preparation, select the “Non-Cemented” tibial instruments. The Cemented instruments will prepare for a 1 mm cement mantle around the periphery of the implant.

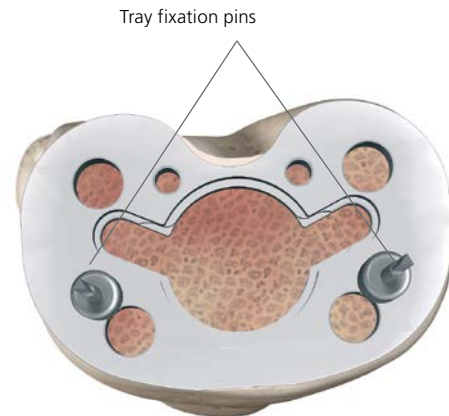

Figure 61



Figure 62



Figure 63

---

### **Keeled Tray Option**

If a keeled MBT tray is to be employed and the bone of the medial or lateral plateau is sclerotic, it is helpful to initially prepare the keel slot with an oscillating saw or high speed burr. Assemble the MBT keel punch impactor to the appropriately-sized MBT keel punch by pressing the side button and aligning the vertical marks on both impactor and keel punch (Figure 64). Insert assembly into the MBT Drill Tower, taking care to avoid malrotation. Impact the assembly into the cancellous bone until the shoulder of the keel punch impactor is in even contact with the MBT Drill Tower (Figure 65).



Figure 64

Figure 65

### **Non-Keeled Tray Option**

For a non-keeled tray option, attach the MBT non-keeled punch and follow the same routine (Figure 66).

### **Final Trialing Option**

A secondary and final trialing step can be performed after tibial preparation. Remove the keel punch impactor from the keel punch by pressing the side button and remove the drill tower as well. Place the trial femoral component on the femur. Then place the appropriate tibial insert trial onto the tray trial and repeat previous trial evaluation.



Figure 66



# Final Patella preparation

Select a template that most adequately covers the resected surface without overhang (Figure 67).

If used, remove the patella wafer from the patella. Position the template handle on the medial side of the everted patella. Firmly engage the template to the resected surface and drill the holes with the appropriate drill bit (Figure 68).



Figure 67



Figure 68

Cement the patellar implant. Thoroughly cleanse the cut surface with pulsatile lavage. Apply cement to the surface and insert the component. The patellar clamp is designed to fully seat and stabilize the implant as the cement polymerizes. Center the silicon O-ring over the articular surface of the implant and the metal backing plate against the anterior cortex, avoiding skin entrapment. When snug, close the handles and hold by the ratchet until polymerization is complete. Remove all extruded cement with a curette. Release the clamp by unlocking the locking switch and squeezing the handle together (Figure 69).

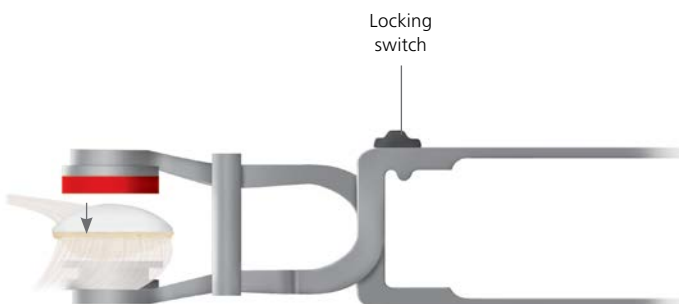

Figure 69

Reduce the patella and evaluate the patella implant. Unrestricted range of motion, free bearing movement and proper patellar tracking should be evident (Figure 70).



Figure 70

# Cementing Technique

Prepare the sclerotic bone to ensure a continuous cement mantle with good cement interdigitation. This can be done by drilling holes and cleansing the bone by pulsatile lavage (Figure 71). Any residual small cavity bone defects should be packed with cancellous autograft, allograft or synthetic bone substitutes such as CONDUIT<sup>®</sup> TCP Granules.

**Note:** Blood lamination can reduce the mechanical stability of the cement, therefore it is vital to choose a cement which reaches its working phase early.

Whether mixed by the SMARTMIX<sup>®</sup> Vacuum Mixing Bowl or the SMARTMIX CEMVAC<sup>®</sup> Cement System, SMARTSET<sup>®</sup> HV Bone Cement or MV Bone Cement offers convenient handling characteristics for the knee cementation process.



Figure 71

A thick layer of cement can be placed either on the bone (Figure 72) or on the implant itself.



Figure 72

# Final Component Implantation

## Tibial Implantation

Attach the MBT tibial impactor by inserting the plastic cone into the implant and tighten by rotating the lock knob clockwise. Carefully insert the tibial tray avoiding malrotation (Figure 73). When fully inserted, several mallet blows may be delivered to the top of the tray inserter. Remove all extruded cement using a curette.

**Optional:** To perform a trial reduction with an insert trial, place the MBT Trial Plateau Post into the tibial tray component and place the insert trial over this post and proceed with the trial reduction (Figure 74).

## Polyethylene Implantation

Remove loose fragments or particulates from the permanent tibial tray. The appropriate permanent tibial insert can be inserted.

## Femoral Implantation

Hyperflex the femur and sublux the tibia forward. Attach the slap hammer or universal handle to the femoral inserter/extractor. Position the appropriately sized femoral component on the inserter/extractor by depressing the two triggers to separate the arms and push the femoral component against the conforming poly. Release the triggers so that the arms engage in the slots on the femoral component and rotate the handle clockwise to lock (Figure 75).

Extend the knee to approximately 90 degrees for final impaction. Release the inserter/extractor by rotating the handle counterclockwise and push the two triggers with thumb and index finger. For final femur impaction, use the femoral notch impactor to seat the femoral component. In SIGMA CS and SIGMA RP-F Instruments (not SIGMA Knee CR) cases the impactor can be used in the notch to prevent adverse flexion positioning (Figure 76). Clear any extruded cement using a curette.

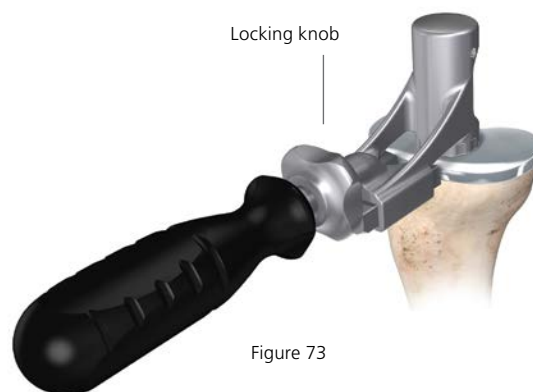

Figure 73



Figure 74

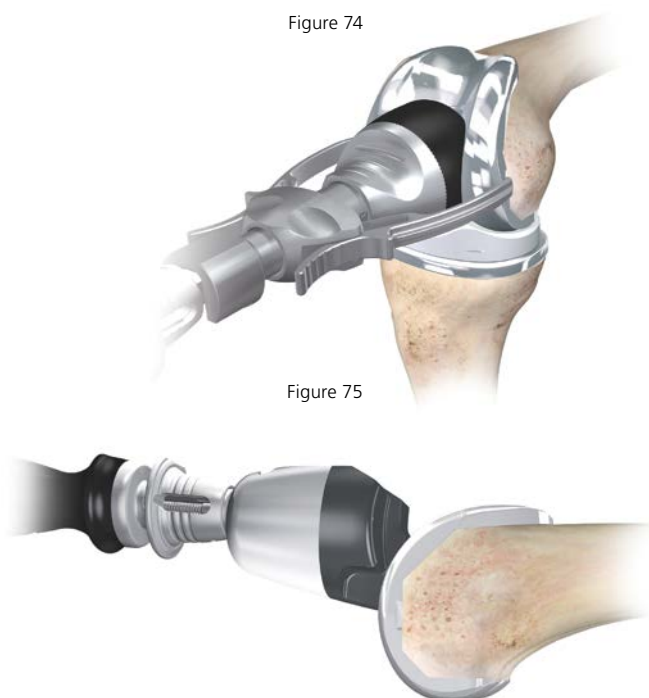

Figure 75



Figure 76

# Closure

---

Release the tourniquet and control bleeding by electrocautery.

Place a closed-wound suction drain in the suprapatellar pouch and bring out through the lateral retinaculum. Reapproximate the fat pad, quadriceps mechanism, patella tendon, and medial retinaculum with interrupted sutures.

Fully rotate the knee from full extension to full flexion to confirm patellar tracking and the integrity of the capsular closing (Figure 77).

**Note: the final flexion against gravity for post-operative rehabilitation. Reapproximate subcutaneous tissue and close the skin with sutures or staple.**



Figure 77

# Appendix A: Fixed Bearing Modular Tibial Preparation

## Femoral Trial

Attach the slap hammer or universal handle to the femoral inserter/extractor. Position the appropriately sized femoral trial on the inserter by depressing the two triggers to separate the arms and push the trial against the conforming poly surface. Release the triggers so that the arms engage in the slots on the femur, and rotate the handle clockwise to lock. Position the trial onto the femur, impacting as necessary. To detach the inserter from the femur, rotate the handle counterclockwise and push the two triggers with thumb and index finger. Position the femoral trial onto the femur (Figure 78).

There are two options available to assess the knee during trial reduction. One or both may be used.

### 1. Trial reduction with the fixed bearing tray trial free to rotate.

- This option is useful when allowing normal internal/external extension of the tibial components during flexion/extension to dictate optimal placement of the tibial tray.
- Select the trial bearing size determined during implant planning and insert onto the tray trial. Place the knee in approximately 90 to 100 degrees of flexion. With the knee in full flexion and the tibia subluxed anteriorly, attach the alignment handle to the tray trial by retracting the lever. Position the tray trial on the resected tibial surface, taking care to maximize the coverage of the tray trial on the proximal tibia (Figure 79).



Figure 78



Figure 79

- With the trial prostheses in place, the knee is carefully and fully extended, noting medial and lateral stability and overall alignment in the A/P and M/L plane. Where there is any indication of instability, substitute the next greater size tibial insert and repeat reduction. Select the insert that gives the greatest stability in flexion and extension and allows full extension. Where there is a tendency for lateral subluxation or patellar tilt in the absence of medial patellar influence (thumb pressure), lateral retinacular release is indicated.
- Adjust rotational alignment of the tibial tray with the knee in full extension, using the alignment handle to rotate the tray and trial insert into congruency with the femoral trial. The appropriate position is marked with electrocautery on the anterior tibial cortex. (Figures 80 and 81).

**2. Trial reduction with the fixed bearing tray trial fixed in place.**

- Assess the position of the tray to achieve maximal tibial coverage (align the tibial tray handle with the electrocautery marks, if procedure described in 1 has been followed.) The rotation of the tray trial is usually centered on the junction between the medial and central one-third of the tibial tubercle. Secure the fixed bearing keel punch impactor to the evaluation bullet and position into the cut-out of the tray trial. Tap down lightly to secure the tray to the proximal tibia (Figure 82).
- Carefully remove the tibial tray handle and repeat the trial reduction step from Step 1.

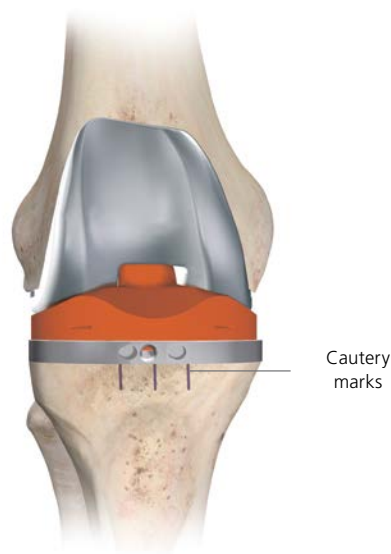

Figure 80



Figure 81



Figure 82

**SIGMA Modular Total Knee System  
& UHMWPE Tray:**

Select the appropriate fixed bearing drill tower, drill bushing, drill and modular keel punch system. Pin the trial with two pins. Remove the alignment handle from the tray trial and assemble the fixed bearing drill tower onto the tray trial (Figure 83).

Fully advance the matching drill through the drill tower into the cancellous bone (Figure 84) to the appropriate line shown in Table below.

Tray Size	Line Color
1.5-3	Green
4-5	Yellow
6	Purple



Figure 83

**Note:** For cemented preparation, select the “Cemented” instruments, and for non-cemented or line-to-line preparation, select the “Non-Cemented” tibial instruments. The Cemented instruments will prepare for a 1 mm cement mantle around the periphery of the implant.

Insert the fixed bearing keel punch impactor and keel punch through the drill tower and impact until the shoulder of the punch is in contact with the guide (Figure 85). Remove the keel punch impactor by pressing the side button taking care that the punch configuration is preserved.

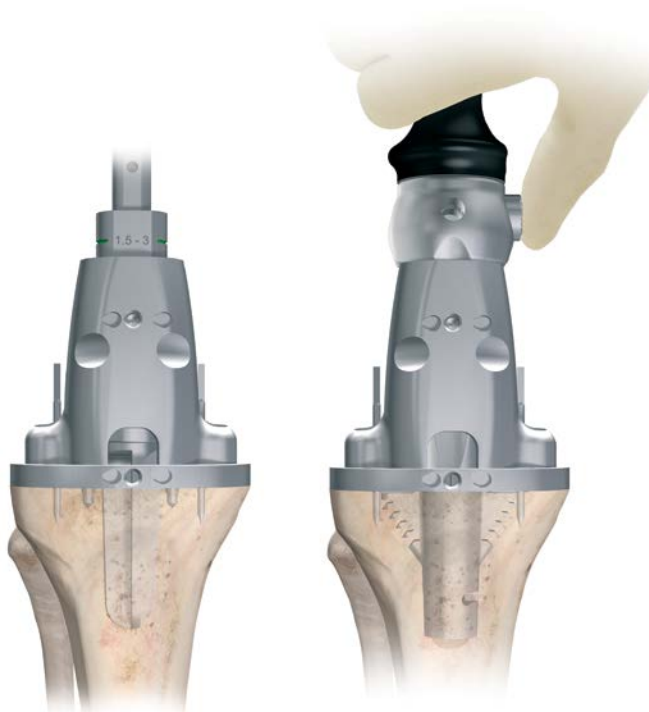

Figure 84

Figure 85

SIGMA Cruciform Keel Tray: Pin the trial with two pins. Remove the alignment handle from the tray trial and assemble the appropriately sized cruciform keel punch guide to the tray trial (Figure 86).



Figure 86

For cemented preparation, sequentially prepare the tibia starting with the standard punch, followed by the cemented punch. For non-cemented preparation, use the standard punch only (Figure 87).

Assemble an appropriately sized standard or cemented keel punch onto the fixed bearing impactor handle. Insert the punch through the guide and impact until the shoulder of the punch is in contact with the guide. Free the stem punch, taking care that the punch configuration is preserved.



Figure 87



## Appendix B: Tibial I.M. Jig Alignment

The entry point for the intramedullary alignment rod is a critical starting point for accurate alignment of the intramedullary alignment system.

In most cases, this point will be centered on the tibial spine in both medial/lateral and anterior/ posterior aspect. In some cases, it may be slightly eccentric.

Flex the knee maximally, insert the tibial retractor over the posterior cruciate ligament and then sublux the tibia anteriorly. All soft tissue is cleared from the intercondylar area. Resect the tibial spine to the highest level of the least affected tibial condyle.

Position the correct size fixed bearing or MBT tray trial on the proximal tibia to aid in establishing a drill point. Drill a hole through the tray trial to open the tibia intramedullary canal with the I.M. step drill (Figure 88). Take care not to use the step portion of the drill. Using the step portion of the drill will create a large diameter hole in the tibia, which in turn creates toggle when using the I.M. Tibial Jig.

The intramedullary rod is passed down through the medullary canal until the isthmus is firmly engaged (Figure 89).



Figure 88



Figure 89

**Optional**

Remove the handle and place the I.M. rotation guide over the I.M. rod to define the correct rotational tibia axis, referring to the condylar axis, medial 1/3 of the tibia tubercle and the center of the ankle (Figure 90).

The angle can also be checked relative to the posterior condylar axis by moving the slider forward and rotating it until it is aligned with the posterior condyles. The marks on the rotation guide are in 2 degree increments and give an indication of the angle between the posterior condylar axis and the chosen rotation.

The rotation can then be marked through the slot on the rotation guide. The rotation guide can then be removed.

Assemble the appropriate 3 degree SIGMA HP Handed (left/right) or Symmetrical Tibia Cutting Block to the HP I.M. tibial jig in line with the marked rotation (Figure 91). After the correct rotation has been marked, slide the I.M. tibial jig over the I.M. rod and rotate the I.M. jig until the rotation is correct (if the rotation guide was used, use the rotation line on the jig and line it up with the previous markings made.)

A 3 degree cutting block is recommended to compensate for the anterior angled I.M. rod position in the I.M. canal. This will prevent an adverse anterior slope position. This results in an overall 0 degree position, which is recommended for the SIGMA Cruciate Substituting Components.

Additional posterior slope can be added through the slope adjustment knob, when using SIGMA Cruciate Retaining Components.

**Note:** The number in the window indicates the amount of ADDITIONAL SLOPE that has been added.



Figure 90

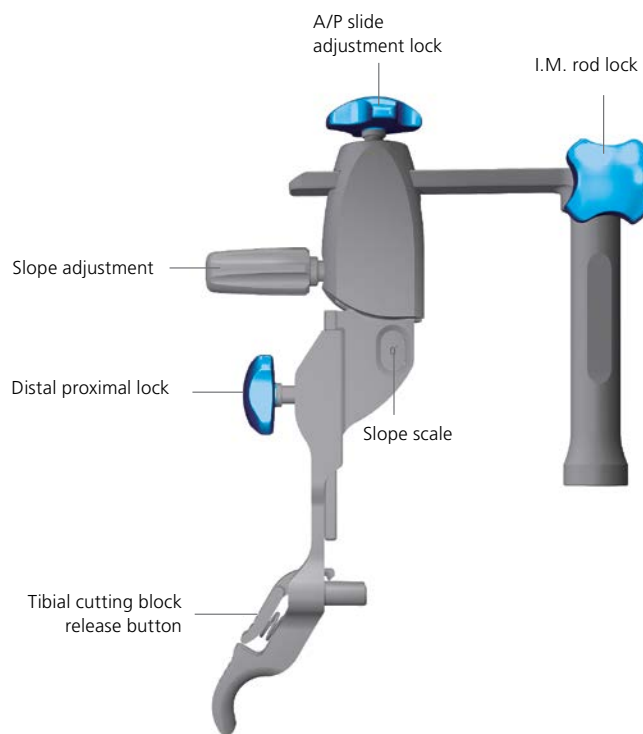

Figure 91

Slide the appropriate fixed or adjustable stylus in the HP tibial cutting block slot. When assessing from the less damaged side of the tibia plateau set the stylus to 8 mm or 10 mm. If the stylus is placed on the more damaged side of the tibia plateau, set the stylus to 0 mm or 2 mm (Figure 92).

Slide the total construct as close as possible towards the proximal tibia and lock this position.

Adjust the correct degree of slope by rotating the slope adjustment screw. For SIGMA Cruciate Retaining Components, a 3 degree slope is recommended. For SIGMA Cruciate Substituting Components a 0 degree slope is recommended as previously described. Ensure that the slope scale reads zero.

Obtain the correct block height by unlocking the distal proximal lock and lowering the bottom half of the block until the stylus is resting on the desired part of the tibia. Lock the device, by turning the distal proximal locking screw, when the correct position has been reached.

After the height has been set, insert two pins through the 0 mm set of holes in the block (the stylus may need to be removed for access). The block can be securely fixed with one extra convergent pin.

+ and -2 mm pinholes are available on the cutting blocks to further adjust the resection level where needed.

Check the position of the resection block with an external alignment guide before making any cut.

Unlock the intramedullary alignment device from the cutting block and remove the I.M. rod (Figure 93).



Figure 92

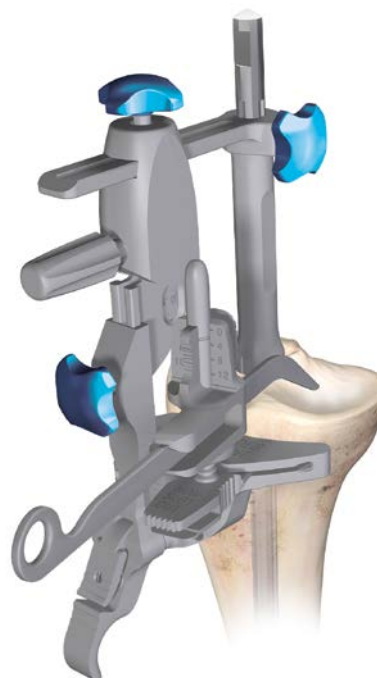

Figure 93

## Appendix C: Spiked Uprod

Assemble the appropriate 0-3 degree, left/right or symmetrical cutting block to the spiked uprod. Slide the spiked uprod into the ankle clamp assembly.

Place the knee in 90 degrees of flexion with the tibia translated anteriorly and stabilized. Place the ankle clamp proximal to the malleoli and insert the larger of the two proximal spikes in the center of the tibial eminence to stabilize the EM alignment device. Loosen the A/P locking knob and position the cutting block roughly against the proximal tibia and lock the knob. Position the cutting block at a rough level of resection and tighten the proximal/distal-sliding knob (Figure 94).



Figure 94

### **Varus/Valgus**

Establish rotational alignment by aligning the tibial jig ankle clamp parallel to the transmalleolar axis. The midline of the tibia is approximately 3-5 mm medial to the transaxial midline.

Translate the lower assembly medially (usually to the second and third vertical mark) by pushing the varus/valgus adjustment wings.

There are vertical scribe marks for reference aligning to the middle of the talus (Figure 95).



Figure 95

---

## Slope

The spiked uprod and ankle clamp are designed to prevent an adverse anterior slope. On an average size tibia, this guide will give approximately a 0 degree tibial slope when the slope adjustment is translated anteriorly until it hits the stop. In some cases, a slight amount of slope will remain (1-2 degrees).

The angle of the tibial slope can be increased to greater than 0 degrees should the patient have a greater natural slope (Figure 96). First, unlock the slide locking position and then translate the tibial slope adjuster anteriorly until the desired angle is reached. For a Cruciate Substituting (CS) design, a 0 degree posterior slope is recommended.

As each patient's anatomy varies, the spiked uprod can be used for both smaller and larger patients. The length of the tibia influences the amount of slope when translating the adapter anteriorly. The 0 degree default position can be overridden by moving the slope adjustment closer to the ankle.

On the spiked uprod 5, 6 and 7 zones are present, which correspond to the length of the tibia. These markings can be used to fine-tune the amount of slope.

When the spiked uprod shows a larger zone (7) marking, this indicates that when the lower assembly is translated 7 mm anterior, it will give an additional 1 degree of posterior slope (Figure 97).



Figure 96



Figure 97

### Height

Loosen the proximal/distal sliding knob, insert the adjustable tibial stylus into the cutting block and adjust to the correct level of resection.

When assessing from the less damaged side of the tibial plateau, set the stylus to 8 mm or 10 mm. If the stylus is placed on the more damaged side of the tibial plateau, set the stylus to 0 mm or 2 mm. Adjustment of resection height on the stylus should be done outside the joint space before locating the stylus in the cutting block.

If planning to resect through the slot, position the foot of the tibial stylus marked "slotted" into the slot of the tibial cutting block (Figure 98). If planning to resect on top of the cutting block, place the foot marked "non-slotted" into the cutting slot. Drop the block and stylus assembly so that the stylus touches the desired point on the tibia. Care should be taken with severe valgus deformity, not to over resect the tibia.

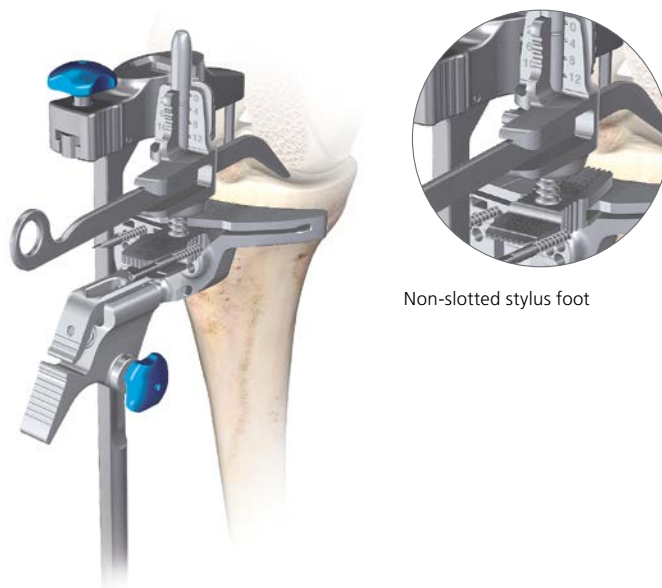

Figure 98

### Tibial Resection

After the height has been set, lock the proximal/ distal sliding knob and pin the block through the 0 mm set of holes (the stylus may need to be removed for access). +/-2 mm pinholes are available on the resection blocks to further adjust the resection level where needed.

The block can be securely fixed with one extra convergent pin.

### Spiked Uprod Removal

Loosen the A/P locking knob. Press the cutting block release button and translate the spiked uprod anterior to disengage from the cutting block.

Connect the slap hammer to the top of the spiked uprod and disengage the spikes from the proximal tibia. Remove the tibial jig and perform the appropriate resection (Figure 99).

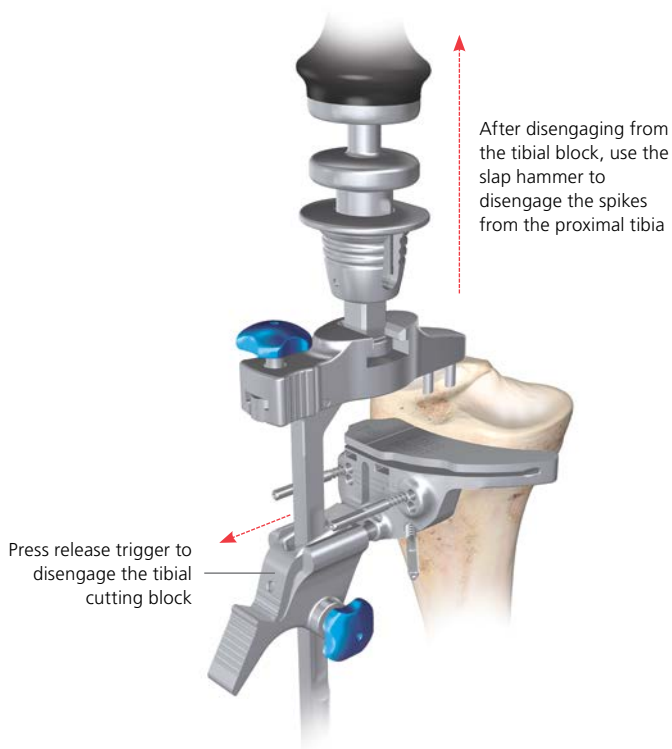

Figure 99

## Appendix D: Femoral Finishing

Resect the anterior cortex using the balanced femoral cutting block. Remove the pins and the resected bone (Figure 100).

Select the appropriate sized SIGMA or SIGMA RP-F Femoral Finishing Block and position the block on the resected anterior and distal surfaces of the femur.



Figure 100

**Note:** The posterior aspect of the block corresponds exactly to the M/L dimension of the final implant and can be used to visualize the correct M/L position. In addition, the anterior flange on the cutting block represents the medial flange of the implant, with the proximal anterior protrusions representing the lateral implant flange (Figure 101).

Pin the block in place through the fixation pinholes with at least three threaded pins before any bone cuts are made. Perform the final resections: posterior resection, notch cut, anterior and posterior chamfer resections (Figure 101).

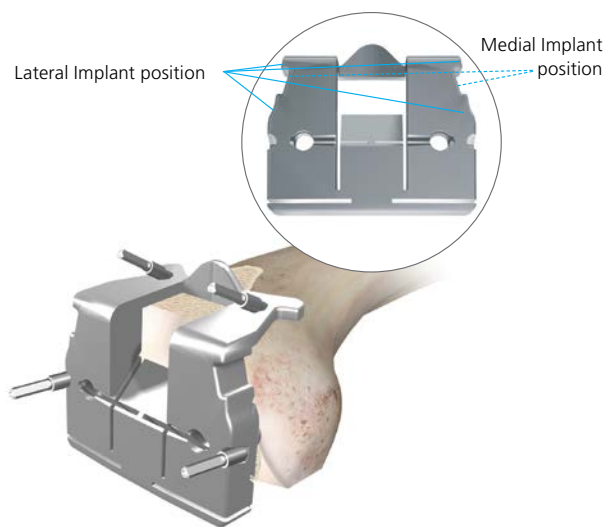

Figure 101

## Appendix E: Femoral Finishing (Optional)

Alternatively use the appropriate SIGMA or SIGMA RP-F A/P Cutting Block to perform the 4-in-1 cuts. To position this block, pin the balanced block through the pin holes located in the middle of the balanced block, (Figure 102) then remove the pins.

Position the appropriate SIGMA or SIGMA RP-F Chamfer Block in the pre-drilled medial and lateral holes. Secure and stabilize the SIGMA or SIGMA RP-F Classic A/P Chamfer Block by drilling a headed drill pin through the central pinhole. Alternatively, medial and lateral pins can be inserted into the convergent pin holes. Place retractors to protect the MCL medially and the popliteal tendon laterally. After securely fixing the femoral chamfer block, resect the anterior cortex, the posterior condyles and the anterior/posterior chamfers (Figure 103).

**Note:** On both the classic A/P chamfer block and the femoral finishing block, the RP-F and standard SIGMA Blocks look very similar. To easily identify them, the RP-F block has the letters “RP-F” on the distal face, and the area above the posterior cut has several grooves.

When using a stabilized SIGMA or SIGMA RP-F Instrument, select and attach the appropriate femoral notch guide. The SIGMA RP-F Instruments and standard SIGMA Notch Guides look very similar. Care should be taken not to confuse the blocks as this will result in under-or-over resection of the box.

**Note:** The RP-F guide can be identified through the letters “RP-F” on the anterior face, and a series of grooves along the notch distal anterior corner.

Position the notch guide on the resected anterior and distal surfaces of the femur. Pin the block in place through the fixation pin holes with at least three pins before any bone cuts are made. Make notch cuts with a small saw blade (Figure 104).

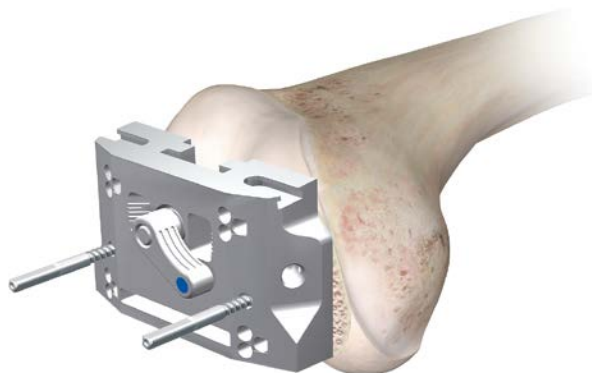

Figure 102

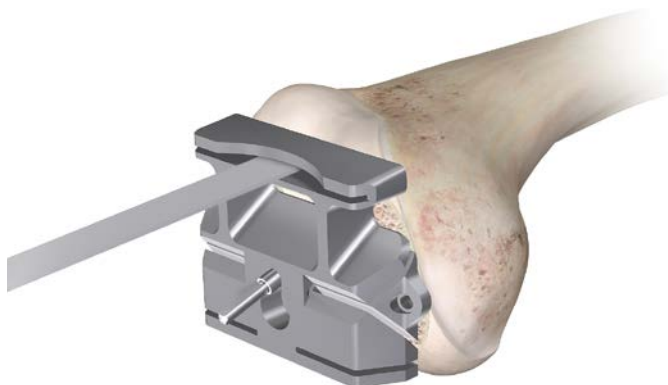

Figure 103



Figure 104



# Ordering Information

## Tibia Resection

9505-01-228	HP EM Tibial Jig Uprod
9505-01-229	HP EM Tibial Jig Ankle Clamp
9505-01-202	HP I.M. Tibia Rotation Guide
9505-01-203	HP I.M. Tibia Jig
9505-01-204	SIGMA HP 0 degrees Symmetrical Cut Block
9505-01-222	SIGMA HP 0 degrees Left Cut Block
9505-01-223	SIGMA HP 0 degrees Right Cut Block
9505-01-205	SIGMA HP 3 degrees Symmetrical Cut Block
9505-01-224	SIGMA HP 3 degrees Left Cut Block
9505-01-225	SIGMA HP 3 degrees Right Cut Block
9505-01-209	SIGMA HP Adj Tibial Stylus
9505-01-230	HP EM Tibial Jig Spiked Uprod
9505-01-164	SIGMA HP Slot Stylus 0/2 mm
9505-01-167	SIGMA HP Nonslotted Stylus 0/2 mm
9505-01-211	SIGMA HP Slotted Stylus 8/10 mm
9505-01-213	SIGMA HP Nonslotted Stylus 8/10 mm

## Femoral Resection

96-6120	SP2 I.M. Rod 400 mm
9505-01-239	SIGMA HP Revision Distal Femoral Cutting Block
99-2011	I.M. Rod Handle
96-6121	I.M. Rod 300 mm
9505-02-079	HP Step I.M. Reamer
9505-01-234	SIGMA HP Distal Femoral Align Guide
9505-01-235	SIGMA HP Distal Femoral Resect Guide
9505-01-238	SIGMA HP Distal Femoral Connector
9505-01-236	SIGMA HP Distal Femoral Block
9505-01-307	HP Alignment Tower
9505-01-207	HP Alignment Rod
96-6530	Reference Guide

## Femoral Sizing

9505-01-263	HP Fixed Reference Femoral Sizer
9505-01-277	HP Classic Posterior Up Femoral Sizer
9505-01-272	HP Classic Anterior Down Femoral Sizer

## Primary Balanced Femoral Resection

9505-02-126	SIGMA HP Balanced A/P Block Size 1.5
9505-02-127	SIGMA HP Balanced A/P Block Size 2
9505-02-128	SIGMA HP Balanced A/P Block Size 2.5
9505-02-129	SIGMA HP Balanced A/P Block Size 3
9505-02-130	SIGMA HP Balanced A/P Block Size 4
9505-02-131	SIGMA HP Balanced A/P Block Size 5
9505-02-132	SIGMA HP Balanced A/P Block Size 6
9505-02-141	SIGMA HP Balanced A/P Block Stylus
9505-02-142	SIGMA HP Balanced I.M. Rod 5 Degrees
9505-02-143	SIGMA HP Balanced I.M. Rod 3 Degrees
9505-02-144	SIGMA HP Balanced RP Femoral Positioner
9505-02-145	SIGMA HP Balanced FB Femoral Positioner
9505-02-146	SIGMA HP Balanced Femoral Positioner Shim 10 mm
9505-02-147	SIGMA HP Balanced Femoral Positioner Shim 12.5 mm

9505-02-148	SIGMA HP Balanced Femoral Positioner Shim 15 mm
9505-02-149	SIGMA HP Balanced Femoral Positioner Shim 17.5 mm
96-6147	Removable Handles (Pack of 2)
9505-02-152	SIGMA HP Fixed Ref AP Block Size 1.5
9505-02-153	SIGMA HP Fixed Ref AP Block Size 2
9505-02-154	SIGMA HP Fixed Ref AP Block Size 2.5
9505-02-155	SIGMA HP Fixed Ref AP Block Size 3
9505-02-156	SIGMA HP Fixed Ref AP Block Size 4
9505-02-157	SIGMA HP Fixed Ref AP Block Size 5
9505-02-158	SIGMA HP Fixed Ref AP Block Size 6
9505-01-000	SP2 MI Fem Notch Guide Size 1.5
9505-01-001	SP2 MI Fem Notch Guide Size 2
9505-01-002	SP2 MI Fem Notch Guide Size 2.5
9505-01-003	SP2 MI Fem Notch Guide Size 3
9505-01-004	SP2 MI Fem Notch Guide Size 4
9505-01-005	SP2 MI Fem Notch Guide Size 5
9505-01-006	SP2 MI Fem Notch Guide Size 6

## Balanced Femoral Resection-Additional Options

9505-01-279	SIGMA HP Femoral Finish Block Size 1.5
9505-01-280	SIGMA HP Femoral Finish Block Size 2
9505-01-281	SIGMA HP Femoral Finish Block Size 2.5
9505-01-282	SIGMA HP Femoral Finish Block Size 3
9505-01-283	SIGMA HP Femoral Finish Block Size 4
9505-01-284	SIGMA HP Femoral Finish Block Size 5
9505-01-285	SIGMA HP Femoral Finish Block Size 6
9505-02-133	RP-F HP Balanced A/P Block Size 1
9505-02-134	RP-F HP Balanced A/P Block Size 1.5
9505-02-135	RP-F HP Balanced A/P Block Size 2
9505-02-136	RP-F HP Balanced A/P Block Size 2.5
9505-02-137	RP-F HP Balanced A/P Block Size 3
9505-02-138	RP-F HP Balanced A/P Block Size 4
9505-02-139	RP-F HP Balanced A/P Block Size 5
9505-02-140	RP-F HP Balanced A/P Block Size 6
9505-01-286	SIGMA RP-F HP Femoral Finish Block Size 1
9505-01-287	SIGMA RP-F HP Femoral Finish Block Size 1.5
9505-01-288	SIGMA RP-F HP Femoral Finish Block Size 2
9505-01-289	SIGMA RP-F HP Femoral Finish Block Size 2.5
9505-01-290	SIGMA RP-F HP Femoral Finish Block Size 3

## Balanced Femoral Resection-Additional Options

9505-01-291	SIGMA RP-F HP Femoral Finish Block Size 4
9505-01-292	SIGMA RP-F HP Femoral Finish Block Size 5
9505-01-293	SIGMA RP-F HP Femoral Finish Block Size 6
96-6278	PFC Chamfer Guides Size 1.5
96-6272	PFC Chamfer Guides Size 2
96-6279	PFC Chamfer Guides Size 2.5
96-6273	PFC Chamfer Guides Size 3
96-6274	PFC Chamfer Guides Size 4
96-6275	PFC Chamfer Guides Size 5
96-6277	PFC Chamfer Guides Size 6

---

**Fixed Bearing Preparation**

9505-02-040	SIGMA HP FBT Tray Trial Size 1.5
9505-02-041	SIGMA HP FBT Tray Trial Size 2
9505-02-042	SIGMA HP FBT Tray Trial Size 2.5
9505-02-043	SIGMA HP FBT Tray Trial Size 3
9505-02-044	SIGMA HP FBT Tray Trial Size 4
9505-02-045	SIGMA HP FBT Tray Trial Size 5
9505-02-046	SIGMA HP FBT Tray Trial Size 6
9505-02-053	SIGMA HP FBT Evaluation Bullet Size 1.5-3
9505-02-054	SIGMA HP FBT Evaluation Bullet Size 4-6
9505-02-055	SIGMA HP FBT Keel Punch Impact
9505-02-060	SIGMA HP FBT Drill Tower
2178-30-123	MBT Tray Fixation Pins
9505-02-028	HP Tibial Tray Handle
9505-02-068	FBT Modular Drill Stop

**Fixed Bearing Modular Tray Preparation**

9505-02-047	HP FBT Cemented Keel Punch Size 1.5-3
9505-02-048	HP FBT Cemented Keel Punch Size 4-5
9505-02-049	HP FBT Cemented Keel Punch Size 6
9505-02-056	SIGMA HP FBT Cemented Drill Size 1.5-3
9505-02-057	SIGMA HP FBT Cemented Drill Size 4-6
9505-02-050	HP FBT Non Cemented Keeled Punch Size 1.5-3
9505-02-051	HP FBT Non Cemented Keeled Punch Size 4-5
9505-02-058	HP FBT Non Cemented Drill Size 1.5-3
9505-02-059	HP FBT Non Cemented Drill Size 4-6
9505-02-052	HP FBT Non Cemented Keeled Punch Size 6

**Fixed Bearing Standard Tray Preparation**

9505-02-061	HP FBT Standard Tibial Punch Guide Size 1.5-4
9505-02-062	HP FBT Standard Tibial Punch Guide Size 5-6
9505-02-063	HP FBT Standard Tibial Punch Size 1.5-2
9505-02-064	HP FBT Standard Tibial Punch Size 2.5-4
9505-02-065	HP FBT Standard Tibial Punch Size 5-6
9505-02-066	HP FBT Standard Cemented Tibial Punch Size 1.5-2
9505-02-067	HP FBT Standard Cemented Tibial Punch Size 2.5-6

---

**MBT Preparation**

9505-02-000	HP MBT Tray Trial Size 1
9505-02-001	HP MBT Tray Trial Size 1.5
9505-02-002	HP MBT Tray Trial Size 2
9505-02-003	HP MBT Tray Trial Size 2.5
9505-02-004	HP MBT Tray Trial Size 3
9505-02-006	HP MBT Tray Trial Size 4
9505-02-007	HP MBT Tray Trial Size 5
9505-02-008	HP MBT Tray Trial Size 6
9505-02-009	HP MBT Tray Trial Size 7
9505-02-022	HP MBT Spiked Evaluation Bullet Size 1-3
9505-02-023	HP MBT Spiked Evaluation Bullet Size 4-7
9505-02-099	HP MBT Evaluation Bullet Size 1-3
9505-02-098	HP MBT Evaluation Bullet Size 4-7
9505-02-027	HP MBT Drill Tower
9505-02-024	HP MBT Keel Punch Impact
2178-30-123	MBT Tray Fixation Pins
9505-02-028	HP Tibial Tray Handle
9505-02-029	MBT Modular Drill Stop
9505-02-038	MBT Central Stem Punch
2178-30-137	MBT RP Trial Button
2178-30-121	MBT RP Plateau Trial Post

**MBT Keeled Preparation**

9505-02-025	HP MBT Cemented Central Drill
9505-02-010	HP MBT Cemented Keel Punch Size 1-1.5
9505-02-011	HP MBT Cemented Keel Punch Size 2-3
9505-02-012	HP MBT Cemented Keel Punch Size 4-7
9505-02-026	HP MBT Non Cemented Central Drill
9505-02-013	HP MBT Non Cemented Keeled Punch Size 1-1.5
9505-02-014	HP MBT Non Cemented Keeled Punch Size 2-3
9505-02-015	HP MBT Non Cemented Keeled Punch Size 4-7

**MBT Non Keeled Preparation**

9505-02-025	HP MBT Cemented Central Drill
9505-02-016	HP MBT Cemented Punch Size 1-1.5
9505-02-017	HP MBT Cemented Punch Size 2-3
9505-02-018	HP MBT Cemented Punch Size 4-7
9505-02-026	HP MBT Non Cemented Central Drill
9505-02-019	HP MBT Non Cemented Punch Size 1-1.5
9505-02-020	HP MBT Non Cemented Punch Size 2-3
9505-02-021	HP MBT Non Cemented Punch Size 4-7

**Femoral Trials**

96-1007	SIGMA Femur Cruciate Retaining Femur Trial Size 1.5 Left
96-1002	SIGMA Femur Cruciate Retaining Femur Trial Size 2 Left
96-1008	SIGMA Femur Cruciate Retaining Femur Trial Size 2.5 Left
96-1003	SIGMA Femur Cruciate Retaining Femur Trial Size 3 Left
96-1004	SIGMA Femur Cruciate Retaining Femur Trial Size 4 Left
96-1005	SIGMA Femur Cruciate Retaining Femur Trial Size 5 Left
96-1006	SIGMA Femur Cruciate Retaining Femur Trial Size 6 Left
96-1017	SIGMA Femur Cruciate Retaining Femur Trial Size 1.5 Right
96-1012	SIGMA Femur Cruciate Retaining Femur Trial Size 2 Right
96-1018	SIGMA Femur Cruciate Retaining Femur Trial Size 2.5 Right
96-1013	SIGMA Femur Cruciate Retaining Femur Trial Size 3 Right
96-1014	SIGMA Femur Cruciate Retaining Femur Trial Size 4 Right
96-1015	SIGMA Femur Cruciate Retaining Femur Trial Size 5 Right
96-1016	SIGMA Femur Cruciate Retaining Femur Trial Size 6 Right
96-6202	Distal Femoral Lug Drill W/Hudson End
96-1047	SIGMA Femur Cruciate Substituting Box Trial Size 1.5
96-1042	SIGMA Femur Cruciate Substituting Box Trial Size 2
96-1048	SIGMA Femur Cruciate Substituting Box Trial Size 2.5
96-1043	SIGMA Femur Cruciate Substituting Box Trial Size 3
96-1044	SIGMA Femur Cruciate Substituting Box Trial Size 4
96-1045	SIGMA Femur Cruciate Substituting Box Trial Size 5
96-1046	SIGMA Femur Cruciate Substituting Box Trial Size 6
96-6295	SP2 Femur Box Trial Screwdriver
2960-00-400	SIGMA CR Femur Trial Size 4N Left
2960-01-400	SIGMA CR Femur Trial Size 4N Right

**RP-F Femoral Trials**

95-4210	RP-F Trial Femur Size 1 Left
95-4211	RP-F Trial Femur Size 1.5 Left
95-4212	RP-F Trial Femur Size 2 Left
95-4213	RP-F Trial Femur Size 2.5 Left
95-4214	RP-F Trial Femur Size 3 Left
95-4215	RP-F Trial Femur Size 4 Left
95-4216	RP-F Trial Femur Size 5 Left
95-4217	RP-F Trial Femur Size 6 Left
95-4220	RP-F Trial Femur Size 1 Right
95-4221	RP-F Trial Femur Size 1.5 Right
95-4222	RP-F Trial Femur Size 2 Right
95-4223	RP-F Trial Femur Size 2.5 Right
95-4224	RP-F Trial Femur Size 3 Right
95-4225	RP-F Trial Femur Size 4 Right
95-4226	RP-F Trial Femur Size 5 Right
95-4227	RP-F Trial Femur Size 6 Right

**Fixed Bearing Insert Trials  
Posterior Lipped**

96-1210	SIGMA PLI Tibial Insert Trial Size 1.5 8 mm
96-1211	SIGMA PLI Tibial Insert Trial Size 1.5 10 mm
96-1212	SIGMA PLI Tibial Insert Trial Size 1.5 12.5 mm
96-1213	SIGMA PLI Tibial Insert Trial Size 1.5 15 mm
96-1214	SIGMA PLI Tibial Insert Trial Size 1.5 17.5 mm
96-1215	SIGMA PLI Tibial Insert Trial Size 1.5 20 mm
96-1220	SIGMA PLI Tibial Insert Trial Size 2 8 mm
96-1221	SIGMA PLI Tibial Insert Trial Size 2 10 mm
96-1222	SIGMA PLI Tibial Insert Trial Size 2 12.5 mm
96-1223	SIGMA PLI Tibial Insert Trial Size 2 15 mm
96-1224	SIGMA PLI Tibial Insert Trial Size 2 17.5 mm
96-1225	SIGMA PLI Tibial Insert Trial Size 2 20 mm
96-1230	SIGMA PLI Tibial Insert Trial Size 2.5 8 mm
96-1231	SIGMA PLI Tibial Insert Trial Size 2.5 10 mm
96-1232	SIGMA PLI Tibial Insert Trial Size 2.5 12.5 mm
96-1233	SIGMA PLI Tibial Insert Trial Size 2.5 15 mm
96-1234	SIGMA PLI Tibial Insert Trial Size 2.5 17.5 mm
96-1235	SIGMA PLI Tibial Insert Trial Size 2.5 20 mm
96-1240	SIGMA PLI Tibial Insert Trial Size 3 8 mm
96-1241	SIGMA PLI Tibial Insert Trial Size 3 10 mm
96-1242	SIGMA PLI Tibial Insert Trial Size 3 12.5 mm
96-1243	SIGMA PLI Tibial Insert Trial Size 3 15 mm
96-1244	SIGMA PLI Tibial Insert Trial Size 3 17.5 mm
96-1245	SIGMA PLI Tibial Insert Trial Size 3 20 mm
96-1250	SIGMA PLI Tibial Insert Trial Size 4 8 mm
96-1251	SIGMA PLI Tibial Insert Trial Size 4 10 mm
96-1252	SIGMA PLI Tibial Insert Trial Size 4 12.5 mm
96-1253	SIGMA PLI Tibial Insert Trial Size 4 15 mm
96-1254	SIGMA PLI Tibial Insert Trial Size 4 17.5 mm
96-1255	SIGMA PLI Tibial Insert Trial Size 4 20 mm
96-1260	SIGMA PLI Tibial Insert Trial Size 5 8 mm
96-1261	SIGMA PLI Tibial Insert Trial Size 5 10 mm
96-1262	SIGMA PLI Tibial Insert Trial Size 5 12.5 mm
96-1263	SIGMA PLI Tibial Insert Trial Size 5 15 mm
96-1264	SIGMA PLI Tibial Insert Trial Size 5 17.5 mm
96-1265	SIGMA PLI Tibial Insert Trial Size 5 20 mm
96-1270	SIGMA PLI Tibial Insert Trial Size 6 8 mm
96-1271	SIGMA PLI Tibial Insert Trial Size 6 10 mm
96-1272	SIGMA PLI Tibial Insert Trial Size 6 12.5 mm
96-1273	SIGMA PLI Tibial Insert Trial Size 6 15 mm
96-1274	SIGMA PLI Tibial Insert Trial Size 6 17.5 mm
96-1275	SIGMA PLI Tibial Insert Trial Size 6 20 mm

**Curved**

96-1320	SIGMA Curved Tibial Insert Trial Size 1.5 8 mm
96-1321	SIGMA Curved Tibial Insert Trial Size 1.5 10 mm
96-1322	SIGMA Curved Tibial Insert Trial Size 1.5 12.5 mm
96-1323	SIGMA Curved Tibial Insert Trial Size 1.5 15 mm
96-1324	SIGMA Curved Tibial Insert Trial Size 1.5 17.5 mm
96-1325	SIGMA Curved Tibial Insert Trial Size 1.5 20 mm
96-1330	SIGMA Curved Tibial Insert Trial Size 2 8 mm
96-1331	SIGMA Curved Tibial Insert Trial Size 2 10 mm
96-1332	SIGMA Curved Tibial Insert Trial Size 2 12.5 mm
96-1333	SIGMA Curved Tibial Insert Trial Size 2 15 mm
96-1334	SIGMA Curved Tibial Insert Trial Size 2 17.5 mm
96-1335	SIGMA Curved Tibial Insert Trial Size 2 20 mm
96-1340	SIGMA Curved Tibial Insert Trial Size 2.5 8 mm
96-1341	SIGMA Curved Tibial Insert Trial Size 2.5 10 mm
96-1342	SIGMA Curved Tibial Insert Trial Size 2.5 12.5 mm
96-1343	SIGMA Curved Tibial Insert Trial Size 2.5 15 mm
96-1344	SIGMA Curved Tibial Insert Trial Size 2.5 17.5 mm
96-1345	SIGMA Curved Tibial Insert Trial Size 2.5 20 mm
96-1350	SIGMA Curved Tibial Insert Trial Size 3 8 mm
96-1351	SIGMA Curved Tibial Insert Trial Size 3 10 mm
96-1352	SIGMA Curved Tibial Insert Trial Size 3 12.5 mm
96-1353	SIGMA Curved Tibial Insert Trial Size 3 15 mm
96-1354	SIGMA Curved Tibial Insert Trial Size 3 17.5 mm
96-1355	SIGMA Curved Tibial Insert Trial Size 3 20 mm
96-1360	SIGMA Curved Tibial Insert Trial Size 4 8 mm
96-1361	SIGMA Curved Tibial Insert Trial Size 4 10 mm
96-1362	SIGMA Curved Tibial Insert Trial Size 4 12.5 mm
96-1363	SIGMA Curved Tibial Insert Trial Size 4 15 mm
96-1364	SIGMA Curved Tibial Insert Trial Size 4 17.5 mm
96-1365	SIGMA Curved Tibial Insert Trial Size 4 20 mm
96-1370	SIGMA Curved Tibial Insert Trial Size 5 8 mm
96-1371	SIGMA Curved Tibial Insert Trial Size 5 10 mm
96-1372	SIGMA Curved Tibial Insert Trial Size 5 12.5 mm
96-1373	SIGMA Curved Tibial Insert Trial Size 5 15 mm
96-1374	SIGMA Curved Tibial Insert Trial Size 5 17.5 mm
96-1375	SIGMA Curved Tibial Insert Trial Size 5 20 mm
96-1380	SIGMA Curved Tibial Insert Trial Size 6 8 mm
96-1381	SIGMA Curved Tibial Insert Trial Size 6 10 mm
96-1382	SIGMA Curved Tibial Insert Trial Size 6 12.5 mm
96-1383	SIGMA Curved Tibial Insert Trial Size 6 15 mm
96-1384	SIGMA Curved Tibial Insert Trial Size 6 17.5 mm
96-1385	SIGMA Curved Tibial Insert Trial Size 6 20 mm

**Curved Plus**

97-2320	SIGMA Curved+ Insert Trial 1.5 8 mm
97-2321	SIGMA Curved+ Insert Trial 1.5 10 mm
97-2322	SIGMA Curved+ Insert Trial 1.5 12.5 mm
97-2323	SIGMA Curved+ Insert Trial 1.5 15 mm
97-2324	SIGMA Curved+ Insert Trial 1.5 17.5 mm
97-2330	SIGMA Curved+ Insert Trial 2 8 mm
97-2331	SIGMA Curved+ Insert Trial 2 10 mm
97-2332	SIGMA Curved+ Insert Trial 2 12.5 mm
97-2333	SIGMA Curved+ Insert Trial 2 15 mm
97-2334	SIGMA Curved+ Insert Trial 2 17.5 mm
97-2335	SIGMA Curved+ Insert Trial 2 20 mm
97-2340	SIGMA Curved+ Insert Trial 2.5 8 mm
97-2341	SIGMA Curved+ Insert Trial 2.5 10 mm
97-2342	SIGMA Curved+ Insert Trial 2.5 12.5 mm
97-2343	SIGMA Curved+ Insert Trial 2.5 15 mm
97-2344	SIGMA Curved+ Insert Trial 2.5 17.5 mm
97-2345	SIGMA Curved+ Insert Trial 2.5 20 mm
97-2350	SIGMA Curved+ Insert Trial 3 8 mm
97-2351	SIGMA Curved+ Insert Trial 3 10 mm
97-2352	SIGMA Curved+ Insert Trial 3 12.5 mm
97-2353	SIGMA Curved+ Insert Trial 3 15 mm
97-2354	SIGMA Curved+ Insert Trial 3 17.5 mm
97-2355	SIGMA Curved+ Insert Trial 3 20 mm
97-2360	SIGMA Curved+ Insert Trial 4 8 mm
97-2361	SIGMA Curved+ Insert Trial 4 10 mm
97-2362	SIGMA Curved+ Insert Trial 4 12.5 mm
97-2363	SIGMA Curved+ Insert Trial 4 15 mm
97-2364	SIGMA Curved+ Insert Trial 4 17.5 mm
97-2365	SIGMA Curved+ Insert Trial 4 20 mm
97-2370	SIGMA Curved+ Insert Trial 5 8 mm
97-2371	SIGMA Curved+ Insert Trial 5 10 mm
97-2372	SIGMA Curved+ Insert Trial 5 12.5 mm
97-2373	SIGMA Curved+ Insert Trial 5 15 mm
97-2374	SIGMA Curved+ Insert Trial 5 17.5 mm
97-2375	SIGMA Curved+ Insert Trial 5 20 mm
97-2380	SIGMA Curved+ Insert Trial 6 8 mm
97-2381	SIGMA Curved+ Insert Trial 6 10 mm
97-2382	SIGMA Curved+ Insert Trial 6 12.5 mm
97-2383	SIGMA Curved+ Insert Trial 6 15 mm
97-2384	SIGMA Curved+ Insert Trial 6 17.5 mm
97-2385	SIGMA Curved+ Insert Trial 6 20 mm

**Stabilized**

96-1410	SIGMA Stabilized Tibial Insert Trial Size 1.5 8 mm
96-1411	SIGMA Stabilized Tibial Insert Trial Size 1.5 10 mm
96-1412	SIGMA Stabilized Tibial Insert Trial Size 1.5 12.5 mm
96-1413	SIGMA Stabilized Tibial Insert Trial Size 1.5 15 mm
96-1414	SIGMA Stabilized Tibial Insert Trial Size 1.5 17.5 mm
96-1420	SIGMA Stabilized Tibial Insert Trial Size 2 8 mm
96-1421	SIGMA Stabilized Tibial Insert Trial Size 2 10 mm
96-1422	SIGMA Stabilized Tibial Insert Trial Size 2 12.5 mm
96-1423	SIGMA Stabilized Tibial Insert Trial Size 2 15 mm
96-1424	SIGMA Stabilized Tibial Insert Trial Size 2 17.5 mm
96-1425	SIGMA Stabilized Tibial Insert Trial Size 2 20 mm
96-1426	SIGMA Stabilized Tibial Insert Trial Size 2 22.5 mm
96-1427	SIGMA Stabilized Tibial Insert Trial Size 2 25 mm
96-1430	SIGMA Stabilized Tibial Insert Trial Size 2.5 8 mm
96-1431	SIGMA Stabilized Tibial Insert Trial Size 2.5 10 mm
96-1432	SIGMA Stabilized Tibial Insert Trial Size 2.5 12.5 mm
96-1433	SIGMA Stabilized Tibial Insert Trial Size 2.5 15 mm
96-1434	SIGMA Stabilized Tibial Insert Trial Size 2.5 17.5 mm
96-1435	SIGMA Stabilized Tibial Insert Trial Size 2.5 20 mm
96-1436	SIGMA Stabilized Tibial Insert Trial Size 2.5 22.5 mm
96-1437	SIGMA Stabilized Tibial Insert Trial Size 2.5 25 mm
96-1440	SIGMA Stabilized Tibial Insert Trial Size 3 8 mm
96-1441	SIGMA Stabilized Tibial Insert Trial Size 3 10 mm
96-1442	SIGMA Stabilized Tibial Insert Trial Size 3 12.5 mm
96-1443	SIGMA Stabilized Tibial Insert Trial Size 3 15 mm
96-1444	SIGMA Stabilized Tibial Insert Trial Size 3 17.5 mm
96-1445	SIGMA Stabilized Tibial Insert Trial Size 3 20 mm
96-1446	SIGMA Stabilized Tibial Insert Trial Size 3 22.5 mm
96-1447	SIGMA Stabilized Tibial Insert Trial Size 3 25 mm
96-1450	SIGMA Stabilized Tibial Insert Trial Size 4 8 mm
96-1451	SIGMA Stabilized Tibial Insert Trial Size 4 10 mm
96-1452	SIGMA Stabilized Tibial Insert Trial Size 4 12.5 mm
96-1453	SIGMA Stabilized Tibial Insert Trial Size 4 15 mm
96-1454	SIGMA Stabilized Tibial Insert Trial Size 4 17.5 mm
96-1455	SIGMA Stabilized Tibial Insert Trial Size 4 20 mm
96-1456	SIGMA Stabilized Tibial Insert Trial Size 4 22.5 mm
96-1457	SIGMA Stabilized Tibial Insert Trial Size 4 25 mm
96-1460	SIGMA Stabilized Tibial Insert Trial Size 5 8 mm
96-1461	SIGMA Stabilized Tibial Insert Trial Size 5 10 mm
96-1462	SIGMA Stabilized Tibial Insert Trial Size 5 12.5 mm
961463	SIGMA Stabilized Tibial Insert Trial Size 5 15 mm
96-1464	SIGMA Stabilized Tibial Insert Trial Size 5 17.5 mm
96-1465	SIGMA Stabilized Tibial Insert Trial Size 5 20 mm
96-1466	SIGMA Stabilized Tibial Insert Trial Size 5 22.5 mm
96-1467	SIGMA Stabilized Tibial Insert Trial Size 5 25 mm
96-1470	SIGMA Stabilized Tibial Insert Trial Size 6 8 mm

96-1471	SIGMA Stabilized Tibial Insert Trial Size 6 10 mm
96-1472	SIGMA Stabilized Tibial Insert Trial Size 6 12.5 mm
96-1473	SIGMA Stabilized Tibial Insert Trial Size 6 15 mm
96-1474	SIGMA Stabilized Tibial Insert Trial Size 6 17.5 mm
96-1475	SIGMA Stabilized Tibial Insert Trial Size 6 20 mm
96-1476	SIGMA Stabilized Tibial Insert Trial Size 6 22.5 mm
96-1477	SIGMA Stabilized Tibial Insert Trial Size 6 25 mm

**Mobile Bearing Insert Trials  
RP Curved**

97-3001	SIGMA RP Curved Tibial Insert Trial Size 1.5 10 mm
97-3002	SIGMA RP Curved Tibial Insert Trial Size 1.5 12.5 mm
97-3003	SIGMA RP Curved Tibial Insert Trial Size 1.5 15.0 mm
97-3004	SIGMA RP Curved Tibial Insert Trial Size 1.5 17.5 mm
96-3011	SIGMA RP Curved Tibial Insert Trial Size 2 10 mm
96-3012	SIGMA RP Curved Tibial Insert Trial Size 2 12.5 mm
96-3013	SIGMA RP Curved Tibial Insert Trial Size 2 15.0 mm
96-3014	SIGMA RP Curved Tibial Insert Trial Size 2 17.5 mm
96-3021	SIGMA RP Curved Tibial Insert Trial Size 2.5 10 mm
96-3022	SIGMA RP Curved Tibial Insert Trial Size 2.5 12.5 mm
96-3023	SIGMA RP Curved Tibial Insert Trial Size 2.5 15.0 mm
96-3024	SIGMA RP Curved Tibial Insert Trial Size 2.5 17.5 mm
96-3031	SIGMA RP Curved Tibial Insert Trial Size 3 10 mm
96-3032	SIGMA RP Curved Tibial Insert Trial Size 3 12.5 mm
96-3033	SIGMA RP Curved Tibial Insert Trial Size 3 15.0 mm
96-3034	SIGMA RP Curved Tibial Insert Trial Size 3 17.5 mm
96-3041	SIGMA RP Curved Tibial Insert Trial Size 4 10 mm
96-3042	SIGMA RP Curved Tibial Insert Trial Size 4 12.5 mm
96-3043	SIGMA RP Curved Tibial Insert Trial Size 4 15.0 mm
96-3044	SIGMA RP Curved Tibial Insert Trial Size 4 17.5 mm
96-3051	SIGMA RP Curved Tibial Insert Trial Size 5 10 mm
96-3052	SIGMA RP Curved Tibial Insert Trial Size 5 12.5 mm
96-3053	SIGMA RP Curved Tibial Insert Trial Size 5 15.0 mm
96-3054	SIGMA RP Curved Tibial Insert Trial Size 5 17.5 mm
96-3061	SIGMA RP Curved Tibial Insert Trial Size 6 10 mm
96-3062	SIGMA RP Curved Tibial Insert Trial Size 6 12.5 mm
96-3063	SIGMA RP Curved Tibial Insert Trial Size 6 15.0 mm
96-3064	SIGMA RP Curved Tibial Insert Trial Size 6 17.5 mm

**RP Stabilized**

97-3101	SIGMA RP Stabilized Tibial Insert Trial Size 1.5 10.0 mm
97-3102	SIGMA RP Stabilized Tibial Insert Trial Size 1.5 12.5 mm
97-3103	SIGMA RP Stabilized Tibial Insert Trial Size 1.5 15.0 mm
97-3104	SIGMA RP Stabilized Tibial Insert Trial Size 1.5 17.5 mm
96-3105	SIGMA RP Stabilized Tibial Insert Trial Size 1.5 20.0 mm
96-3111	SIGMA RP Stabilized Tibial Insert Trial Size 2 10.0 mm
96-3112	SIGMA RP Stabilized Tibial Insert Trial Size 2 12.5 mm
96-3113	SIGMA RP Stabilized Tibial Insert Trial Size 2 15.0 mm
96-3114	SIGMA RP Stabilized Tibial Insert Trial Size 2 17.5 mm
96-3115	SIGMA RP Stabilized Tibial Insert Trial Size 2 20.0 mm
96-3116	SIGMA RP Stabilized Tibial Insert Trial Size 2 22.5 mm
96-3117	SIGMA RP Stabilized Tibial Insert Trial Size 2 25 mm
96-3121	SIGMA RP Stabilized Tibial Insert Trial Size 2.5 10.0 mm
96-3122	SIGMA RP Stabilized Tibial Insert Trial Size 2.5 12.5 mm
96-3123	SIGMA RP Stabilized Tibial Insert Trial Size 2.5 15.0 mm
96-3124	SIGMA RP Stabilized Tibial Insert Trial Size 2.5 17.5 mm
96-3125	SIGMA RP Stabilized Tibial Insert Trial Size 2.5 20.0 mm
96-3126	SIGMA RP Stabilized Tibial Insert Trial Size 2.5 22.5 mm
96-3127	SIGMA RP Stabilized Tibial Insert Trial Size 2.5 25 mm
96-3131	SIGMA RP Stabilized Tibial Insert Trial Size 3 10.0 mm
96-3132	SIGMA RP Stabilized Tibial Insert Trial Size 3 12.5 mm
96-3133	SIGMA RP Stabilized Tibial Insert Trial Size 3 15.0 mm
96-3134	SIGMA RP Stabilized Tibial Insert Trial Size 3 17.5 mm
96-3135	SIGMA RP Stabilized Tibial Insert Trial Size 3 20.0 mm
96-3136	SIGMA RP Stabilized Tibial Insert Trial Size 3 22.5 mm
96-3137	SIGMA RP Stabilized Tibial Insert Trial Size 3 25 mm
96-3141	SIGMA RP Stabilized Tibial Insert Trial Size 4 10.0 mm
96-3142	SIGMA RP Stabilized Tibial Insert Trial Size 4 12.5 mm
96-3143	SIGMA RP Stabilized Tibial Insert Trial Size 4 15.0 mm
96-3144	SIGMA RP Stabilized Tibial Insert Trial Size 4 17.5 mm
96-3145	SIGMA RP Stabilized Tibial Insert Trial Size 4 20.0 mm
96-3146	SIGMA RP Stabilized Tibial Insert Trial Size 4 22.5 mm
96-3147	SIGMA RP Stabilized Tibial Insert Trial Size 4 25 mm
96-3151	SIGMA RP Stabilized Tibial Insert Trial Size 5 10.0 mm
96-3152	SIGMA RP Stabilized Tibial Insert Trial Size 5 12.5 mm
96-3153	SIGMA RP Stabilized Tibial Insert Trial Size 5 15.0 mm
96-3154	SIGMA RP Stabilized Tibial Insert Trial Size 5 17.5 mm
96-3155	SIGMA RP Stabilized Tibial Insert Trial Size 5 20.0 mm
96-3156	SIGMA RP Stabilized Tibial Insert Trial Size 5 22.5 mm
96-3157	SIGMA RP Stabilized Tibial Insert Trial Size 5 25 mm
96-3161	SIGMA RP Stabilized Tibial Insert Trial Size 6 10.0 mm
96-3162	SIGMA RP Stabilized Tibial Insert Trial Size 6 12.5 mm
96-3163	SIGMA RP Stabilized Tibial Insert Trial Size 6 15.0 mm
96-3164	SIGMA RP Stabilized Tibial Insert Trial Size 6 17.5 mm
96-3165	SIGMA RP Stabilized Tibial Insert Trial Size 6 20.0 mm
96-3166	SIGMA RP Stabilized Tibial Insert Trial Size 6 22.5 mm
96-3167	SIGMA RP Stabilized Tibial Insert Trial Size 6 25 mm

**RP-F**

95-4110	RP-F Tibial Insert Trial 10 mm Size 1
95-4111	RP-F Tibial Insert Trial 12.5 mm Size 1
95-4112	RP-F Tibial Insert Trial 15 mm Size 1
95-4113	RP-F Tibial Insert Trial 17.5 mm Size 1
95-4114	RP-F Tibial Insert Trial 10 mm Size 1.5
95-4115	RP-F Tibial Insert Trial 12.5 mm Size 1.5
95-4116	RP-F Tibial Insert Trial 15 mm Size 1.5
95-4117	RP-F Tibial Insert Trial 17.5 mm Size 1.5
95-4120	RP-F Tibial Insert Trial 10 mm Size 2
95-4121	RP-F Tibial Insert Trial 12.5 mm Size 2
95-4122	RP-F Tibial Insert Trial 15 mm Size 2
95-4123	RP-F Tibial Insert Trial 17.5 mm Size 2
95-4125	RP-F Tibial Insert Trial 10 mm Size 2.5
95-4126	RP-F Tibial Insert Trial 12.5 mm Size 2.5
95-4127	RP-F Tibial Insert Trial 15 mm Size 2.5
95-4128	RP-F Tibial Insert Trial 17.5 mm Size 2.5
95-4130	RP-F Tibial Insert Trial 10 mm Size 3
95-4131	RP-F Tibial Insert Trial 12.5 mm Size 3
95-4132	RP-F Tibial Insert Trial 15 mm Size 3
95-4133	RP-F Tibial Insert Trial 17.5 mm Size 3
95-4140	RP-F Tibial Insert Trial 10 mm Size 4
95-4141	RP-F Tibial Insert Trial 12.5 mm Size 4
95-4142	RP-F Tibial Insert Trial 15 mm Size 4
95-4143	RP-F Tibial Insert Trial 17.5 mm Size 4
95-4150	RP-F Tibial Insert Trial 10 mm Size 5
95-4151	RP-F Tibial Insert Trial 12.5 mm Size 5
95-4152	RP-F Tibial Insert Trial 15 mm Size 5
95-4153	RP-F Tibial Insert Trial 17.5 mm Size 5
95-4160	RP-F Tibial Insert Trial 10 mm Size 6
96-4161	RP-F Tibial Insert Trial 12.5 mm Size 6
95-4162	RP-F Tibial Insert Trial 15 mm Size 6
95-4163	RP-F Tibial Insert Trial 17 mm Size 6

**Patella Resection**

9505-01-121	SIGMA HP Patella Resection Guide
9505-01-242	SIGMA HP Patella Resection Stylus 32-38 mm
9505-01-243	SIGMA HP Patella Resection Stylus 41 mm
9505-01-247	SIGMA HP Patella Resection Stylus 12mm Remnant
9505-01-923	HP Patella Wafer Small
9505-01-623	HP Patella Wafer Large
86-9188	Patella Calliper
86-5035	Patella Clamp
86-8801	Oval Patella Drill w/Hudson End
96-1100	PFC*SIGMA Oval/Dome Patella Trial 3 Peg 32 mm
96-1101	PFC*SIGMA Oval/Dome Patella Trial 3 Peg 35 mm
96-1102	PFC*SIGMA Oval/Dome Patella Trial 3 Peg 38 mm
96-1103	PFC*SIGMA Oval/Dome Patella Trial 3 Peg 41 mm
96-6601	Patellar Drill Guide 38 mm & 41 mm
96-6602	Patellar Drill Guide 32 mm & 35 mm

**Spacer Blocks  
Fixed Bearing**

9505-02-105	SIGMA HP FBT Spacer Block 8 mm
9505-02-106	SIGMA HP FBT Spacer Block 10 mm
9505-02-107	SIGMA HP FBT Spacer Block 12.5 mm
9505-02-108	SIGMA HP FBT Spacer Block 15 mm
9505-02-109	SIGMA HP FBT Spacer Block 17.5 mm
9505-02-110	SIGMA HP FBT Spacer Block 20 mm
9505-02-111	SIGMA HP FBT Spacer Block 22.5 mm
9505-02-112	SIGMA HP FBT Spacer Block 25 mm
9505-02-113	SIGMA HP FBT Spacer Block 30 mm
9505-02-193	Flexion/Extension Cap Size 6

**Mobile Bearing**

9505-02-114	HP MBT Spacer Block 10 mm
9505-02-115	HP MBT Spacer Block 12.5 mm
9505-02-116	HP MBT Spacer Block 15 mm
9505-02-117	HP MBT Spacer Block 17.5 mm
9505-02-118	HP MBT Spacer Block 20 mm
9505-02-119	HP MBT Spacer Block 22.5 mm
9505-02-120	HP MBT Spacer Block 25 mm
9505-02-121	HP MBT Spacer Block 30 mm
9505-02-193	Flexion/Extension Cap Size 6

**RP-F**

9505-02-104	SIGMA RP-F HP Flex SHIM Size 1
9505-02-100	SIGMA RP-F HP Flex SHIM Size 1.5
9505-02-101	SIGMA RP-F HP Flex SHIM Size 2
9505-02-102	SIGMA RP-F HP Flex SHIM Size 2.5-5
9505-02-103	SIGMA RP-F HP Flex SHIM Size 6
9505-02-193	Flexion/Extension Cap Size 6

**Pinning**

9505-02-070	HP Pin Impactor/Extractor
9505-02-071	HP Power Pin Driver
9505-02-072	HP Quick Pin Drills
9505-02-073	HP Quick Pin Drills Headed
9505-02-088	HP Threaded Pins
9505-02-089	HP Threaded Pins Headed
2267-12-000	Smooth 3 Inch Pins (5 Pack)
9505-02-300	SIGMA HP Quick Drill Pins-Sterile
9505-02-302	SIGMA HP Threaded Pins-Sterile
9505-02-303	SIGMA HP Threaded Pins Headed-Sterile

**Insertion Femur**

9505-01-218	SIGMA HP Femoral Notch Impactor
9505-01-171	HP Femoral Imp/Ext
9505-01-308	HP Slap Hammer
9505-01-305	HP Universal Handle

**Mobile Bearing Tibia**

9505-01-558	MBT Tibial Impactor
96-5383	MBT Tray Impactor
9505-01-559	MBT Tibial Impactor Replacement Parts

**Fixed Bearing Tibia**

9505-01-306	SIGMA FB Tibial Impactor
2581-11-000	F.B.T. Tray Inserter
96-6385	F.B.T. Poly PS
9505-01-170	SIGMA FBT Tibia Impactor Replacement Parts
96-6384	F.B.T. Tray Inserter

**Anterior First**

9505-02-090	SIGMA HP Anterior 1st Resection Guide
9505-02-092	SIGMA HP Anterior 1st Ledge Size 1.5-2
9505-02-093	SIGMA HP Anterior 1st Ledge Size 2.5-3
9505-02-094	SIGMA HP Anterior 1st Ledge Size 4-6
9505-02-095	SIGMA HP Anterior 1st Femoral Alignment Guide
9505-02-096	SIGMA HP Anterior 1st Femoral Resection Guide

**Re-cut Kit**

9505-01-294	SIGMA HP Re-cut Blk +2 mm
9505-01-295	SIGMA HP Re-cut Blk +3 Deg
9505-01-296	SIGMA HP Re-cut Blk 2 Deg V/V Left
9505-01-297	SIGMA HP Re-cut Blk 2 Deg V/V Right
9505-01-394	SIGMA HP Re-cut Kit Reference Arm
9505-01-395	SIGMA HP Re-cut Kit Slotted Adapter

**Instrument Trays**

**General**

9505-02-800	HP Base Femur & Tibia
9505-02-802	SIGMA HP Spacer Blocks
9505-02-808	SIGMA HP Patella & Insertion Instruments
9505-02-840	SIGMA HP Insertion Instruments

**Femoral Sizing & Resection**

9505-02-801	SIGMA HP Fixed Reference Femur Preparation
9505-02-803	SIGMA HP RP-F Fixed Reference Femur Preparation
9505-02-810	SIGMA HP Classic Reference Femur Preparation
9505-02-809	SIGMA HP RP-F Classic Reference Femur Preparation
9505-02-811	SIGMA HP Balanced Femur Preparation
9505-02-816	SIGMA HP RP-F Balanced Femur Preparation
9505-02-820	SIGMA HP Femoral Finishing Blocks
9505-02-826	SIGMA HP Macro Case
9505-02-843	SIGMA HP Micro Case

---

**Fixed Bearing Preparation & Trials**

9505-02-812	SIGMA HP FB Tibial Preparation
9505-02-837	SIGMA HP Standard Tibial Guides & Punches
9505-02-835	SIGMA HP FB PLI Insert Trials
9505-02-813	SIGMA HP Curved Insert Trials
9505-02-814	SIGMA HP Stabilized Insert Trials
9505-02-827	SIGMA HP Curved Plus Case
9505-02-833	SIGMA HP FB Micro 1.5 Trial Case
9505-02-834	SIGMA HP FB Macro Trial Case

**Mobile Bearing Preparation & Trials**

9505-02-806	SIGMA HP MBT Tibia Preparation
9505-02-807	SIGMA HP RP Insert Trial
9505-02-832	SIGMA HP Macro RP Insert Case
9505-02-842	SIGMA HP RP Micro Insert Case

**Femoral Trials**

9505-02-804	SIGMA HP Femoral Trials
9505-02-815	SIGMA HP RP-F Trials

**Miscellaneous**

9505-02-841	SIGMA HP Quick Kit FB Case
9505-02-823	SIGMA HP Quick Kit Base Case
9505-02-824	SIGMA HP Quick Kit MBT Case
9505-02-821	SIGMA HP Upgrade #1 Case
9505-02-825	SIGMA HP Anterior First Case
9505-02-830	SIGMA HP Recut Kit Case



# Total and Unicompartmental Knee Prostheses

## Important:

This Essential Product Information sheet does not include all of the information necessary for selection and use of a device. Please see full labeling for all necessary information.

## Intended Use:

Total or unicompartmental knee arthroplasty is intended to provide increased patient mobility and reduced pain by replacing the damaged knee joint articulation in patients where there is evidence of sufficient sound bone to seat and support the components. Total or unicompartmental knee replacement may be considered for younger patients if, in the opinion of the surgeon, an unequivocal indication for total or unicompartmental knee replacement outweighs the risks associated with the age of the patient, and if limited demands regarding activity and knee joint loading can be assured. This includes severely crippled patients with multiple joint involvement for whom a gain in knee mobility may lead to an expectation of significant improvement in the quality of their lives.

## Indications:

Candidates for total or unicompartmental knee replacement include patients with a severely painful and/or severely disabled joint resulting from osteoarthritis, post-traumatic arthritis, rheumatoid arthritis, or a failed previous implant. In candidates for unicompartmental knee arthroplasty, only one side of the joint (the medial or lateral compartment) is affected.

**THE SIGMA C/R POROCOAT FEMORAL COMPONENTS ARE INTENDED FOR CEMENTED OR CEMENTLESS USE AS THE FEMORAL COMPONENT OF A TOTAL KNEE REPLACEMENT SYSTEM.**

**IN THE US THIS POROUS COATED COMPONENT HAS BEEN CLEARED FOR CEMENTED USE ONLY.**

**ANY NON-POROUS COATED COMPONENT IS INTENDED FOR CEMENTED USE ONLY.**

## Contraindications:

The following conditions are contraindications for total or unicompartmental knee replacement:

1. Active local or systemic infection.
2. Loss of bone or musculature, osteoporosis, neuromuscular compromise or vascular deficiency in the affected limb in sufficient degree to render the procedure unjustifiable (e.g., absence of musculoligamentous supporting structures, joint neuropathy).
3. Severe instability secondary to advanced loss of osteochondral structure or the absence of collateral ligament integrity.
4. Unicompartmental knee replacement is contraindicated in patients with a severe (over 30°) fixed valgus or varus deformity.

**NOTE:** Diabetes, at present, has not been established as a contraindication. However, because of the increased risk for complications such as infection,

slow wound healing, etc., the physician should carefully consider the advisability of knee replacement in the severely diabetic patient.

## Warnings and Precautions:

### CAUTION:

- **Implants and trial components from different manufacturers or implant systems should never be used together.**
- **Knee prosthesis components should never be reimplanted. Even though the implant appears undamaged, the implant may have developed microscopic imperfections which could lead to failure.**
- **Always use a trial prosthesis for trial purposes. Trials should not be assembled with any components intended for permanent implantation. Trials must have the same configuration size, as the corresponding components to be permanently implanted.**
- **Do not alter or modify implants in any way.**
- **Avoid drilling multiple pin holes in the proximal tibia which may affect the compressive strength of the tibia.**

**These total and unicompartmental knee prostheses have not been evaluated for safety and compatibility in the MR environment. These total and unicompartmental knee prostheses have not been tested for heating or migration in the MR environment. The risks of exposure to MR include heating and/or displacement of a metallic implant. Image artifacts including dead zones and distortion may occur, especially in the immediate area around the implant, requiring optimization of imaging parameters. Please refer to current local MR safety guidelines for additional investigation, patient monitoring and patient follow-up advice. DePuy recommends that a professional familiar with the specific MRI apparatus to be used, assess the patient prior to any MRI examination of or therapy.**

CAUTION: The following conditions, singularly or concurrently, tend to impose severe loading on the affected extremity thereby placing the patient at higher risk of failure of the knee replacement:

1. Obesity or excessive patient weight.
2. Manual Labor.
3. Active sports participation.
4. High levels of patient activity.
5. Likelihood of falls.
6. Alcohol or drug addiction.
7. Other disabilities, as appropriate.

In addition to the above, the following physical conditions, singularly or concurrently, tend to adversely affect the fixation of knee replacement implants:

1. Marked osteoporosis or poor bone stock.
2. Metabolic disorders or systemic pharmacological treatments leading to progressive deterioration of solid bone support for the implant (e.g., diabetes

mellitus, steroid therapies, immunosuppressive therapies, etc.).

3. History of general or local infections.
4. Severe deformities leading to impaired fixation or improper positioning of the implant.
5. Tumors of the supporting bone structures.
6. Allergic reactions to implant materials (e.g. bone cement, metal, polyethylene).
7. Tissue reactions to implant corrosion or implant wear debris.
8. Disabilities of other joints (i.e., hips or ankles).

A higher incidence of implant failure has been reported in paraplegics and in patients with cerebral palsy or Parkinson Disease.

WHEN THE SURGEON DETERMINES THAT KNEE REPLACEMENT IS THE BEST MEDICAL OPTION AVAILABLE AND DECIDES TO USE THIS PROSTHESIS IN A PATIENT WHO HAS ANY OF THE ABOVE CONDITIONS OR WHO IS SIMPLY YOUNG AND ACTIVE, IT IS IMPERATIVE THAT THE PATIENT BE INSTRUCTED ABOUT THE STRENGTH LIMITATIONS OF THE MATERIALS USED IN THE DEVICE AND FOR FIXATION AND THE RESULTANT NEED TO SUBSTANTIALLY REDUCE OR ELIMINATE ANY OF THE ABOVE CONDITIONS.

The surgical and postoperative management of the patient must be carried out with due consideration for all existing conditions. Mental attitudes or disorders resulting in a patient's failure to adhere to the surgeon's orders may delay postoperative recovery and/or increase the risk of adverse effects including implant or implant fixation failure.

Excessive physical activity or trauma to the replaced joint may contribute to premature failure of the knee replacement by causing a change in position, fracture, and/or wear of the implants. **The functional life expectancy of prosthetic knee implants is, at present, not clearly established.** The patient should be informed that factors such as weight and activity levels may significantly affect wear.

DePuy's Single Use devices have not been designed to undergo or withstand any form of alteration, such as disassembly, cleaning or re-sterilization, after a single patient use. Reuse can potentially compromise device performance and patient safety.

## Adverse Events:

The following are the most frequent adverse events after knee arthroplasty: change in position of the components, loosening, tibial subsidence, bending, cracking, fracture, deformation or wear of one or more of the components, infection, tissue reaction to implant materials or wear debris; pain, dislocation, subluxation, flexion contracture, decreased range of motion, lengthening or shortening of leg caused by improper positioning, looseness or wear of components; fractures of the femur or tibia.





Limited Warranty and Disclaimer: DePuy Synthes products are sold with a limited warranty to the original purchaser against defects in workmanship and materials. Any other express or implied warranties, including warranties of merchantability or fitness, are hereby disclaimed.

Please also refer to the package insert(s) or other labeling associated with the devices identified in this surgical technique for additional information.

CAUTION: Federal Law restricts these devices to sale by or on the order of a physician.

Some devices listed in this surgical technique may not have been licensed in accordance with Canadian law and may not be for sale in Canada.

Please contact your sales consultant for items approved for sale in Canada.

Not all products may currently be available in all markets.



**DePuy Orthopaedics, Inc.**

700 Orthopaedic Drive  
Warsaw, IN 46582  
USA

Tel: +1 (800) 366-8143  
Fax: +1 (800) 669-2530

[www.depuysynthes.com](http://www.depuysynthes.com)

**DePuy International, Ltd.**

St Anthony's Road  
Leeds LS11 8DT  
England

Tel: +44 (0) 113 270 0461

**DePuy (Ireland)**

Loughbeg, Ringaskiddy  
Co. Cork  
Ireland

Tel: + 353 21 4914 000  
Fax: + 353 21 4914 199



**Enztec Limited**

26 Dakota Crescent  
Stockburn, Christchurch  
8042, New Zealand

